

2026



YANG BEY IND. CO., LTD

2026 CATALOG



Your Partner
in Every Package.

From trusted packing tools
to expert consulting,
serving clients worldwide.

We deliver in 25 days!



Website



YouTube



LinkedIn



元貝實業股份有限公司

YANG BEY INDUSTRIAL CO., LTD.

42942 台中市神岡區豐工南路50號(豐洲工業區)

50, Fenggong S. Rd., Shengang Dist., Taichung City 42942, Taiwan

Tel : 886-4-25320779

Fax : 886-4-25319186 886-4-25335616

www.yangbey.com.tw

www.ybico.com.tw

Your Partner in Every Package

1



Void Filling

2



Paper Cushioning

6



Edge Protector Cutting

5



Tape Dispensing

4



Bubble Wrapping

3



Packaging Labeling

7



Pallet Strapping

8



Load Wrapping

9



Film Cutting

Company Introduction

Founded in 1979, Yang Bey has become a leading manufacturer of strapping tools and packing tools in Taiwan. Our products have been sold to over 85 countries. Our customers are importers and/or distributors from packaging, material handling, or logistic industry. Some customers themselves are manufacturers for strapping, tapes, stretch film, etc. We far realized that helping our customers to reduce their cost and time is a way to create our value. We, therefore, challenge ourselves to be a one-stop-shop supplier. Our customers can reduce communication time, minimum order quantity, transportation costs and inventory expense if we are able to supply them as many tools as possible from one source and in timely manner. Our **lead time is 25 days** for standard products. They can focus on sales and expansion of business. With this target in mind and 40-year-experience, we have developed a complete cross section product line that includes strapping tools, seals/buckles, banding tools, clamping tools, film dispensers, tape dispensers, label dispensers, bag sealers, paper cutters, utility knives, bubble wrap dispensers, etc.



It is the initials of **Yang Bey Industrial CO., Ltd.** We understand the difficulty of establishing and maintaining a sound brand image and therefore, all our products are **made in Taiwan** by trained labors and professional managements to ensure quality consistency. Also **USD 1 million product liability insurance** is applied to all our productions as a service and support to our tool users. We want our customers to feel not only good but also safe to use them. If you are interested in any tool in this brochure, don't hesitate to contact our sales team. We are here to serve you.



Company Introduction

All our products are made in Taiwan.
We situated in Taichung where is the 2nd-largest city in Taiwan.
Port Taichung is 1 hour from our factory.

Taichung is also a center of tools and machinery of Taiwan. We have plenty of potential resources including abundant amount of subcontractors who are experienced in many processes. Most of our subcontractors are within 30 minutes. The advantage of short distance enables us to work and talk with our partners closely and we can control the quality of components in timely manner.



▲ Showroom



▲ Cafeteria



▲ Showroom



WE ARE HERE !





▲ Automated Storage and Retrieval System



▲ Automated Storage and Retrieval System



▲ Automated Storage and Retrieval System



▲ Going Green



▲ Going Green



▲ Coordinate Measuring Machine



▲ Stress Transfer Testing Machine



▲ Life Testing Machine



▲ Instant Measurement System

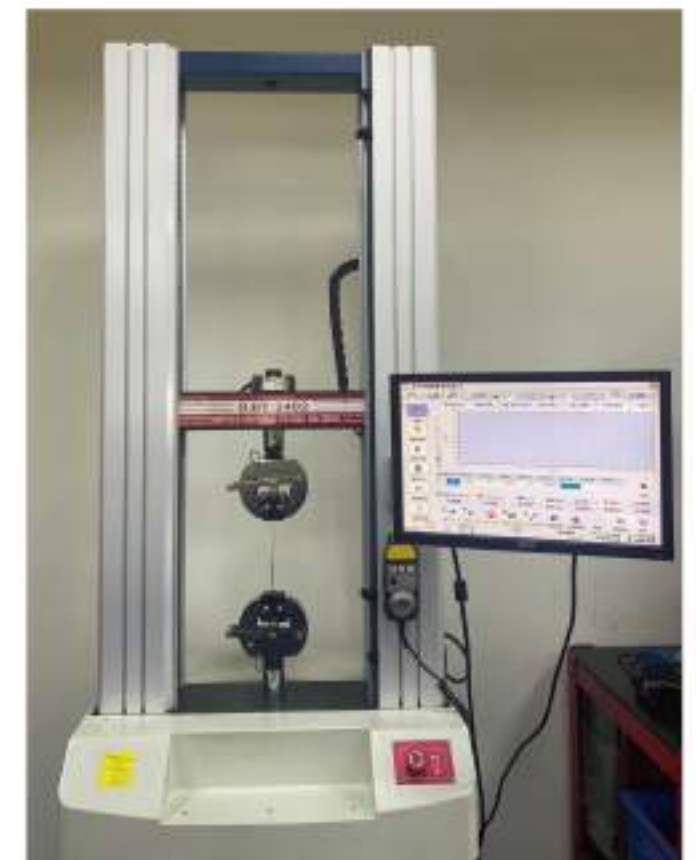

▲ Compression and tensile testing machine



▲ QC



▲ QC



▲ QC



▲ Tension Test



▲ Container Dock



▲ Laser Etching



▲ CNC Processing



▲ Assembling



▲ Employee Training



▲ Employee Training



▲ Corporate Family Day



▲ Corporate Family Day



▲ Corporate Family Day



▲ Corporate Family Day

















▲ Corporate Family Day

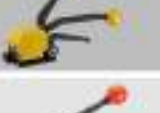





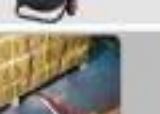

























▲ Corporate Family Day



▲ Annual Bonus Distribution

	Plastic Strapping Tensioners	15
	Pneumatic Cord Strapping Tools	30
	Plastic Strapping Sealers	32
	Seals for Plastic Strapping	35
	Buckles and Carton Edge Protectors	36
	Cardboard Edge Protector Cutters	37
	Pneumatic Steel Strapping Tools	41
	Sealless Combination Tools	42
	Steel Strapping Tensioners	43
	Steel Strapping Sealers	49
	Seals for Steel Strapping	51
	Steel Strapping Cutters	52
	Strap Choppers	57
	Find the Right Dispenser	59
	Strapping Dispensers	61
	Lacing Rods	72

	Drop-in Strapping Dispenser	73
	Tool Balancer Dispenser	74
	Pallet Strap Dispenser	77
	Stainless Steel Banding Tools	80
	Stainless Steel Wing Seals	83
	Plastic Totes and Stainless Steel Band Benders	84
	Stainless Steel Banding Cutters	85
	Clamping Tools	86
	Center Punch Tools	87
	Cable Tie Guns	88
	Masking Film Dispensers	89
	Protection Film Applicators	90
	Aluminum Profile Tape Dispensers	91
	Joist/Flashing Tape Dispenser	92
	Stretch Film Dispensers	93
	Coreless Film Wrappers	103

	Stretch Film Cutters	104
	Multi-function Cutters	105
	Multi-function Cutters and Lashing Cutters	109
	Utility Knives	110
	Replacement Blades	111
	Carton Sizers, Staplers and Staple Removers	112
	Paper Cutters	113
	Paper Crumpler	115
	Void Fill Dispensers	116
	Cutter Stands for Packing Material	117
	Line Marking Handles	122
	Floor Marking Tape Tools	123
	Impulse Heat Sealers	124
	Create Your Own Tape Dispensers	127
	Our Safety Retractable Blade & Easy Replaced Wiper	128

	Tape Dispensers	129
	Mini Tape Dispensers	140
	Adhesive Transfer Tape and Dot Tape Dispensers	141
	VHB Tape Dispenser and Drywall Joint Tape Dispensers	142
	Filament Tape Dispensers	143
	Handy Tape Dispensers	144
	Tear Drop Tape Dispensers	145
	Tape Folding Dispensers	146
	Desk-Top Tape Dispensers	147
	Pouch Tape Dispensers	152
	Water Activated Tape Dispenser	153
	Tape Liner Removers	154
	Bag Sealers	155
	Label Dispensers	157
	Auto Label Dispensers	159



PP



Smooth PET



Embossed PET



VIDEO

► P 108

Rack tensioner with metal cutter handle
For 1/2" - 3/4" PP strapping.



Tighten the strap and insert the seal



Crimp the seal

metal cutter handle



► P 260

Heavy duty tensioner with oilless bearings in handle and base.
For 3/8" - 3/4" PP & PET strapping.
It is an up-graded tool with stronger base and modified gripper that will not get stuck during operations.



◀ P 270

Heavy duty tensioner with oilless bearings in handle and base.
For 3/8" - 3/4" PP & PET strapping.



► P 276

Heavy duty tensioner with oilless bearings in handle and base.
For PP & PET strapping up to 1".



◀ P 116

Tensioner with oilless bearings in handle and base.
Gripper wheel gives greater tension.
For 3/8" - 3/4" PET strapping thickness from 1mm up .



► P 117

Tensioner with oilless bearings in handle and base.
For 3/8" - 3/4" PP & PET strapping.



VIDEO

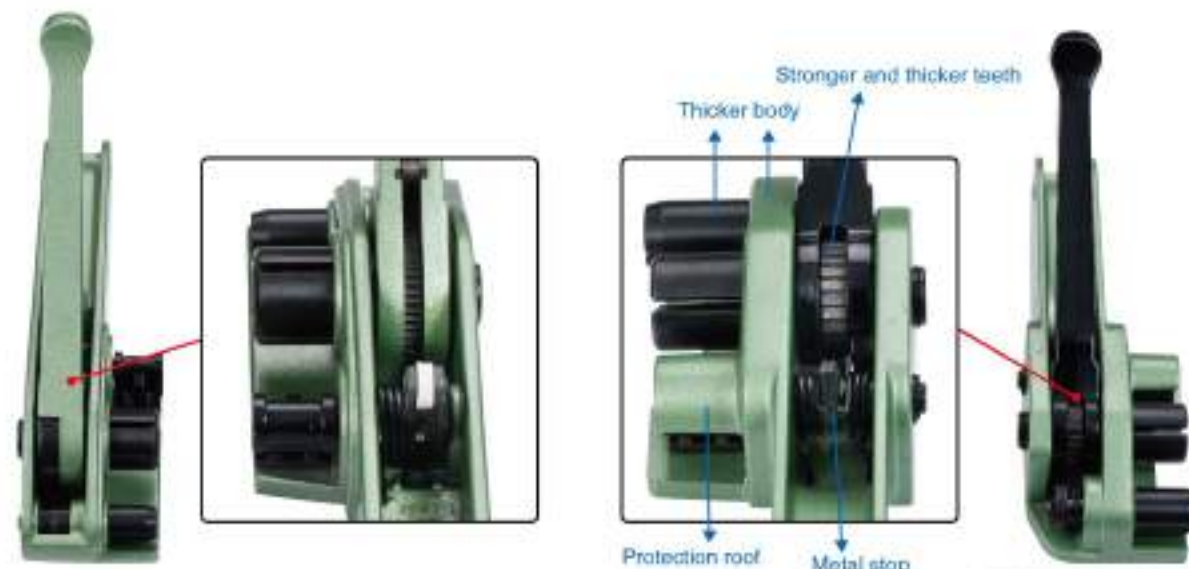

P117 Regular Duty

P270 Heavy Duty

► **P 330**

Tensioner with oilless bearings in handle and base.
For 1/2" - 3/4" PP & PET strapping.



Tighten the strap



Crimp the seal



VIDEO

Tension PP strap



VIDEO

Tension PET strap



► **P 395**

Heavy duty aluminum tensioner with oilless bearings in handle and base.
For 1/2" - 3/4" PP, PET strapping.



VIDEO



◄ **YP 370**



VIDEO

Industrial quality medium duty tensioner for 1/2"-3/4" PP, PET, composite, woven strapping.
Aluminum base with copper bushings in handle and base.



► **PQ 300**

Heavy duty premium tensioner with one way bearings in handle and base.
For 3/8" - 3/4" PP & PET strapping.
Feels lighter and reduces fatigue. One way bearings enable the handle to tension smoothly without annoying voice.



◄ **PQ 302**

For 3/8"-3/4" PP & PET Strapping
Features a reinforced structure for greater strength and stability.
Dual one-way bearings in the handle and base provide smooth, quiet, and effortless tensioning.

- Features:
- Integrated PQ300-33 nose kit.
 - Ergonomic handle reduces operator fatigue.
 - Durable structure for heavy-duty use.

► **PQ 300-33**

Nose Kit. Can be ordered as accessory.



► **P 460**

Large heavy duty aluminum tensioner with oilless bearings in handle and base.
For 1/2"-1-1/4" PP, PET strapping.



VIDEO



PP



Smooth PET



Embossed PET

► P 173



Hand Pull Tensioner with Built-in Cutter

Perfect for small businesses, logistics, and outdoor packaging operations, offering a convenient and efficient bundling solution.

Applications :

- Compatible with 12-19mm PP/PE/Cord straps.
- Designed to work seamlessly with plastic buckles and steel wire buckles for smooth operation.

Key Features :

- **Durable Metal Body with Ergonomic T-Handle :**
Provides a comfortable grip for stable and reliable operation.
- **Enclosed Blade for Safety :**
Small opening design minimizes the risk of finger injuries during use.
- **Lightweight and Portable :**
Compact design makes it easy to carry, ideal for mobile and on-the-go applications.
- **All-in-One Combination Tool :**
Functions as a strapping tensioner and cutter, efficiently handling polypropylene (PP) and cord straps for tensioning and cutting tasks.



Tension the strap



CPB 4 / CPB 5 / CPB 42



Cut the excess strap



► PE 1044
PE 1045



VIDEO

Heavy duty combination tool for smooth and embossed PET strapping. Tensioning, sealing and cutting all in one. ****Good quality serrated seal is important to achieve the desired sealing performance.**
PE 1044: 1/2". Use with gripper seal.
PE 1045: 5/8". Use with gripper seal.



Insert seal



Tension the strap



Close the seal



Cut the strap and move away



- ▶ **P 1604**
- ▶ **P 1614**
- ▶ **P 1605**
- ▶ **P 1615**

Combination tool (tensioning, sealing and cutting all in one) for PP strapping. One-Piece Molded Base: Designed with no seams or joints, this base maximizes strength and stability while minimizing maintenance needs, reducing costs and saving time.

P 1604 for 1/2" PP strapping thickness from 0.5mm up. Use with CP 04 seals.

P 1614 for 1/2" PP strapping thickness up to 0.5mm. Use with CP 04 seals.

P 1605 for 5/8" PP strapping thickness from 0.5mm up. Use with CP 05 seals.

P 1615 for 5/8" PP strapping thickness up to 0.5mm. Use with CP 05 seals.



CP 04 / CP 05



- ◀ **P 1624**
- ◀ **P 1625**

Combination tool (tensioning, sealing and cutting all in one) for PP strapping.

P 1624 for 1/2" PP strapping thickness from 0.5mm up. Use with CP 04 seals.

P 1625 for 5/8" PP strapping thickness from 0.5mm up. Use with CP 05 seals.



VIDEO



Woven



Hot melt



Composite

- ▶ **P 119**

Tensioner with oilless bearings in handle and base. For 3/8" - 3/4" hot melt, composite & woven strapping.



- ▶ **P 243**

Tensioner with oilless bearings in handle and bearings in base. For 3/8" - 1" hot melt, composite & woven strapping.



VIDEO



- ▶ **P 310**

Tensioner with oilless bearings in handle and base. For 3/8" - 3/4" hot melt, composite & woven strapping.



VIDEO



- ▶ **P 391**

Heavy duty aluminum tensioner with oilless bearings in handle and base. For 3/8" - 3/4" hot melt, composite & woven strapping.



- ▶ **P 180**

Twin gripper tensioner with built-in cutter for 1/2" - 5/8" PP strapping. Use with wire buckle.



Wire buckle





◀ **PQ 220**

Light weight tensioner with oilless bearing in handle and base.
For 1/2" - 3/4" PP, PET, hot melt, composite & woven strapping.

▶ **P 277**

Heavy duty tensioner with oilless bearings in handle and base.
For hot melt, composite & woven strapping up to 1".



◀ **P 278**

Heavy duty tensioner with nose function for PET, hot melt, composite & woven strapping up to 1".
Ideal for round and irregular packages.
Use with wire buckle.



Wire buckle



▶ **YP 380**



Industrial quality heavy duty tensioner for 1/2" - 3/4" PP, PET, composite & woven strapping.
Zinc base with copper bushings in handle and base.





▼ **P 472**
P 482

Giant heavy duty aluminum tensioner with oilless bearings in handle and base.
For PET, composite and woven strapping.
P 472: For 3/4" - 1-1/2".
P 482: For 1" - 2".



► **P 475**

Giant heavy duty aluminum tensioner with nose function for round and irregular packages.
For 3/4" - 1-1/2" PET, composite and woven strapping.



◀ **P 4750-NS**

Nose Kit. Can be ordered as accessory.



◀ **P 476**
P 486

For PET, composite, woven cord strap and medium duty lashing strap.
Base is a combination of aluminum and steel.
Comparable to tool made of steel in the market but a lot lighter in weight.



P 476: For 3/4" - 1-1/2"
P 486: For 1-2".

► **P 190**

T-bar tensioner for cord strap up to 2" wide and thickness up to 1/8"(3mm).



▼ P 580



Robust tool with a base that combines the light weight of aluminum and the strength of steel. It weighs only 3.2 kgs so it is easy to use but also strong enough to handle heavy duty tasks. For heavy duty woven strap, composite strap or lashing from 1-1/2" -2". Handle pawl design allows the user to move the handle to a position that is easy to apply more tension to the strap.



- 1. Handle release pawl allows reposition of handle during operation.
- 2. Ergonomic handle.
- 3. Leg designed to lift with vertical motion.
- 4. Windlass rotates clockwise and anti-clockwise.
- 5. Bigger clearance between windlass and other parts. This allows longer strap to be coiled on the windlass.
- 6. Pawl release pin.
- 7. Thicker and durable ratchet wheel.
- 8. Base is a mix of steel and aluminum.
- 9. Specially designed teeth to give greater holding power.
- 10. For cord or lashing strap up to 50mm.

◀ P 582

No cutter device. Only 2.9 kgs.



▶ P 585

With nose design. Work great with round or irregular object. Tool weighs 3.5 kgs.



◀ P 587

With nose design but no cutter device. Tool weighs 3.1 kgs.



▶ P 589

Without leg design, ideal for cutting irregular or uneven straps.



P 580

P 486

▼ PH 350



Heavy duty windlass tensioner. Windlass can be adjusted so the slot is in line with angle of strap. One piece of CN 180 lashing strap cutter included.
PH 350: For woven strap up to 2" wide.



▼ CN 180

Lashing strap cutter that cuts thick and strong strap in any angles easily. Also with a splitter that cut tapes.
 Rotary blade is sharp and with long life time.



▼ PA 472



Pneumatic tensioner with manual cutter for composite strapping, woven strapping and lashing up to 1-1/2" (40mm) x 2mm thick. The windlass can spin forward to tension the strap and after cutting the strap, it can spin backward to release the strap.

Max. Tension : 7500N
 Max. Air Pressure: 7 bar



► PA 473

No cutter device and nose design.
 Lighter weight. Good for flat or square package.





◀ PA 475

Nose device is included as an accessory. When nose device is installed, it can be used for round or irregular package. In the other hand, can use on flat or square package when nose not installed.

▶ PA 476

No gripper device but with nose. Good for round or irregular package.



◀ PA 477

No cutter device and gripper device. Very light weight. Good for round or irregular package.



VIDEO



▶ C 1004
C 1005



VIDEO

PP/PV strapping sealer. Adjustable nut allows the user to control the sealing depth. Whole tool is heat-treated.

- C 1004 : 1/2" PP strapping. Use with CP 24 seal.
- C 1005: 5/8" PP strapping. Use with CP 25 seal.



▶ C 3004
C 3014
C 3005
C 3015
C 3016
C 3026



VIDEO

PP strapping sealer. Whole tool is heat-treated.

- C 3004: 1/2" PP strapping. Use with CP 04/ CP 14 seal. Handle length 13".
- C 3014: 1/2" PP strapping. Use with CP 04/ CP 14 seal. Handle length 17".
- C 3005: 5/8" PP strapping. Use with CP 05/ CP 15 seal. Handle length 13".
- C 3015: 5/8" PP strapping. Use with CP 05/ CP 15 seal. Handle length 17".
- C 3016: 3/4" PP strapping thickness up to 0.6mm. Use with CP 16 seal. Handle length 17".
- C 3026: 3/4" PP strapping thickness from 0.6mm up. Use with CP 16 seal. Handle length 17".



▶ C 3304
C 3364
C 3305
C 3365



VIDEO

PP strapping sealer. Whole tool is heat-treated.

- C 3304: 1/2" PP strapping. Use with CP 04/ CP 14 seal. Handle length 14".
- C 3364: 1/2" PP strapping. Use with CP 04/ CP 14 seal. Handle length 17".
- C 3305: 5/8" PP strapping. Use with CP 05/ CP 15 seal. Handle length 14".
- C 3365: 5/8" PP strapping. Use with CP 05/ CP 15 seal. Handle length 17".



► **C 5004**
C 5005
C 5015
C 5006
 (off-set type)

High quality 17" handle PET strapping sealer. Whole tool is heat-treated.

- C 5004: 1/2" PET strapping. Use with gripper seal.
- C 5005: 5/8" PET strapping. Use with gripper seal.
- C 5015: 5/8" PET strapping thickness from 0.8mm up. Use with gripper seal.
- C 5006: 3/4" PET strapping thickness up to 0.8mm.



◄ **C 5304**
C 5305
C 5315
 (off-set type)

Unique labor saving designed PET strapping sealer. Handle length 16.5".

- C 5304: 1/2" PET strapping thickness up to 0.7mm. Use with gripper seal.
- C 5305: 5/8" PET strapping thickness up to 0.7mm. Use with gripper seal.
- C 5315: 5/8" PET strapping thickness up to 1mm. Use with gripper seal.



► **C 5324**
C 5325
 (symmetrical type)

PET strapping sealer with unique design that reduces sealing fatigue. Symmetrical jaws eliminate the need to orient the tool on non-symmetrical seal.

Good for strap thickness up to 1 mm. Handle length 16.5".

- C 5324: 1/2". Use with gripper seal.
- C 5325: 5/8". Use with gripper seal.



► **C 5416**
 (symmetrical type)

Heavy duty 3/4" PET strapping sealer with unique design that reduces sealing fatigue.

Symmetrical jaws eliminate the need to orient the tool on non-symmetrical seal.

Good for strap thickness up to 1.2 mm. Handle length 16.5". Use with CP 3602 gripper seals or seal as shown below.



◄ **C 600**
C 601
 (symmetrical type)

Heavy duty front action sealer for 3/4" PET strapping. Handle length 20". Use with CP 3602 gripper seal.

- C 600: PET strapping thickness up to 0.8mm.
- C 601: PET strapping thickness from 0.8 to 1mm.



► **C 620**
C 621

Side action sealer for 3/4" PET strapping. Handle length 25". Use with CP 3602 gripper seal.

- C 620: 3/4" PET strapping thickness from 0.8 to 1mm.
- C 621: 3/4" PET strapping thickness from 1 to 1.2mm.



◄ **C 635**
 (off-set type)

Heavy duty front action sealer for 3/4" PET strapping thickness from 0.8 to 1mm.

Handle length 20". Use with gripper seal as shown below.



▶ **CP 04**
CP 05

Open seals for PP strapping. 25 mm long.

- CP 04 for 1/2" straps.
Use with P1604 / P1614 / P1624 / C3004 / C3014 / C3304 / C3364.
- CP 05 for 5/8" straps.
Use with P1605 / P1615 / P1625 / C3005 / C3015 / C3365.



CP04 / CP05

▶ **CP 14**

Open seals for 1/2" PP strapping. 29mm long.

- Compatible Sealers:
Use with C3004, C3014, C3304, C3364
- Packaging Details:
• 1,000 pcs per box
• 6 boxes per carton (6,000 pcs per carton)
Sales Unit: Sold by carton (6,000 pcs)

▶ **CP 15**

Open seals for 5/8" PP strapping. 29mm long.

- Compatible Sealers:
Use with C3005, C3015, C3305, C3365
- Packaging Details:
• 1,000 pcs per box
• 3 boxes per carton (3,000 pcs per carton)
Sales Unit: Sold by carton (3,000 pcs)



CP14 / CP15 / CP16

▶ **CP 16**

Open seals for 3/4" PP strapping. 29mm long.

- Compatible Sealers:
Use with C3016, C3026
- Packaging Details:
• 1,000 pcs per box
• 3 boxes per carton (3,000 pcs per carton)
Sales Unit: Sold by carton (3,000 pcs)

▶ **CP 25**

Closed seals (push-type seals) for PP strapping.

- CP 25 for 5/8" straps.
Use with C 1005



CP25

▶ **CP 3602**

3/4" gripper (serrated) seals for PET straps thickness from 0.8 to 1.3mm. Seal thickness 2mm.
Use with C 600 / C 601 / C 620 / C 621.



CP3602

▶ **CPB 4**
CPB 5



VIDEO

Plastic buckles ideal for light-duty applications. Suitable for use with PP or cord strapping. Straps can be tightened by hand or with the P173 hand pull tensioner.

- CPB4 Size: 1/2"
 - CPB5 Size: 5/8"
- Packaging: 1,000 pcs per box, 6 boxes per carton (6,000 pcs per carton).
Sales Unit: Sold by carton (6,000 pcs).



CPB4 / CPB5



◀ **CPB 62**

Description: Plastic buckle with patented foot lock for easier operation

- Suitable for use with PP or cord strapping. Straps can be tightened by hand or with the P173 hand pull tensioner.
- CPB62 Size: 3/4"
- Packaging: 1,000 pcs per box, 3 boxes per carton (3,000 pcs per carton).
Sales Unit: Sold by carton (3,000 pcs).

▶ **CWB 5-H**
CWB 6-H

Wire metal buckle for PP, PET, woven strapping. Phosphated finish.

- CWB 5-H : 5/8"
- CWB 6-H : 3/4"

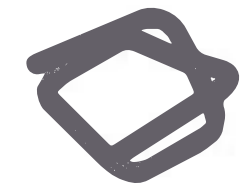

◀ **CG 19**

Carton Edge Protector
Prevents straps from slipping on cartons.
Specifications:
• Material: PE (Polyethylene)
• Size: 3/4"
Packaging: 1,000 pcs per carton
Sales Unit: Sold by carton (1,000 pcs)



◀ **CG 32**

Carton Edge Protector
Prevents straps from slipping on cartons.
Specifications:
• Material: PE (Polyethylene)
• Size: 1-1/4"
Packaging : 1,000 pcs per carton
Sales Unit: Sold by carton (1,000 pcs)

◀ **CGS 32**

Carton Edge Protector
Provides robust edge protection and prevents strap slippage.
Specifications:
• Material: Metal
• Size: 1-1/4"
Packaging:
• 250 pcs per box
• 2 boxes per carton (Total: 500 pcs per carton)
Sales Unit: Sold by carton (500 pcs)

Edge Protector Cutter



Safety

Eliminate risks of finger cutting.
Increase work safety.
Free from workplace safety lawsuit.



Fast & Professional

Cut effectively and neat.
With quick and precise performances,
user can get more done in a short
amount of time.



VIDEO



Customized your size

No need to stock different sizes in
volume. Cut the protectors to the
sizes you need when you need
them.



Portable

User can carry it to any job site.
Do your jobs in cramped space
much easier.

Additional Accessories

▼ AC110-125-01

Angle board support base.
A thoughtful accessory to add to the
dispenser when cutting a great amount of
edge protector a day.
It acts like a support pillow to your elbow. It
also increases to precision of inserting the
edge protector to the slot of cutter.



VIDEO

▼ T9610-21-01

C-clamps. Secure to a bench or table
with bolts or C-clamps.



▼ AC120-021-01

Length Measurement.
A ruler with max. 50 cm scale.



VIDEO

• **Safety**

Safety should be always the
top priority at work. Safe
protection shields to prevent
your fingers from harm.



• **Neat Edge**

Provide easy cut and perfect
finish on very cut.

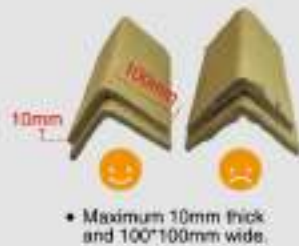

• Maximum 10mm thick
and 100*100mm wide.

• **Customized Sizes**

Use up every bit without waste!
Eco-friendly and cost-effective
device in the long run.



• **Portable**

Safety locking pin for portable
usage. Easy for hand carry.



• **Low Maintenance**

No expensive repair parts needed.
Only need to replace blades and
cutting board when dull.
Sharp stainless steel blade last up
to 10,000 cuts.



VIDEO VIDEO

• **Maximum Efficiency**

You could do 2 or 3 layers in
one cut to save time.



• **Ergonomic Handle**

Neoprene grip for comfortable
and long lasting use.



• **Supply Holder**

Organized your supplies. A storage
bin for rulers, pencils, marker,
pens...etc.



ITEM NO	DESCRIPTION	Cardboard Edge Protector Cutter	AC110-125-01	AC120-021-01	PHOTO
AC110	Portable cardboard edge protector cutter.	•			
AC111	Same as AC110 yet with angle board support base.	•	•		
AC123	Same as AC110 yet with a ruler with max. 50 cm scale.	•		•	
AC124	Same as AC123 yet with angle board support base.	•	•	•	
AC100-63	Spare blades. 2 pcs/set.				
AC110-99	Cutting board. Replacement of cutting board is needed when it is damaged or the dispenser cannot achieve clean cut to the protector while the blades are still sharp.				





▼ **SA 104**
SA 105
SA 106

Pneumatic pusher type for steel strapping tool that produces a single notch seal joint. Use with closed seal. Ideal for flat or round surfaces.

Strapping Thickness: 0.015" ~ 0.025" (0.38mm ~ 0.63mm)

Max. Tension: 4500N
Air Pressure: 4.5 ~ 6 bar
Tool Weight: 4.9 kgs

- SA 104: 1/2". Use with closed seal.
- SA 105: 5/8". Use with closed seal.
- SA 106: 3/4". Use with closed seal.



► **SL 200**



Sealless steel strapping tool.
Strap Gauge range from 0.015" ~ 0.027".
One tool works for 1/2", 5/8" and 3/4".
Tensioning, sealing and cutting all in one.

► **SL 220**

With SL 220-90 base protector installed in SL 200 tool.



◀ **SL 220-90**

This is an additional accessory for SL 200 and SL 210. It is used as a base protector to prevent the tool body from scratch or damage during the operation.



Tension the strap



Seal and cut the strap

► **SL 210**

Same as SL 200 but all plastic material are with -40 degree Celsius resistance. Ideal for cold working environment.

► **SL 230**

With SL 200-90 base protector installed in SL 210 tool.





◀ S 210



VIDEO

Push bar tensioner with breaker nose to cut the strap. Use with closed seals.
For 3/8" - 3/4" x 0.02" max. steel strapping.
Good for round, irregular or non-compressible packages.



CLOSED SEAL

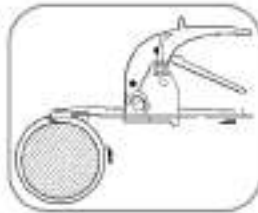

▶ S 220



VIDEO

Rack tensioner for 3/8" - 3/4" x 0.03" max steel strapping.
Use with open seal.
Good for flat packaging. Need cutter.



◀ S 227



VIDEO

Rack pusher tensioner with nose function for 3/8" - 1-1/4" x 0.015" - 0.031" steel strapping.
Use with closed seal.



▶ S 246



VIDEO

Pusher tensioner for 3/8" - 3/4" x 0.023" max. steel strap.
Use with closed seal.
Ideal for irregular and flat package.



◀ S 223



VIDEO

Tensioner with cutter and hammer function.
For steel strap up to 3/4" x 0.031".



▶ S 225

Rack tensioner with duckwork and built-in cutter for 3/8" - 3/4" steel strapping.
Ideal for round and irregular packages.
Use with closed seal.



◀ S 259



VIDEO

Use with closed seal.
Ideal for irregular and flat package.
For 3/4" - 1-1/4" x 0.035" max. steel strap.



▶ S 249

Pusher feedwheel tensioner for 3/4" - 1-1/4" x 0.6-1.2mm max. steel strapping. Use with closed seal or wing seal when applying steel straps. Use with wire buckle when applying PET straps.



◀ S 250

Light duty feedwheel tensioner for small packaging. For 3/8" - 5/8" x 0.02" max. steel strapping.



◀ S 290

Feedwheel tensioner for steel strapping 3/8" - 3/4" x 0.035". Good for flat packages.



▶ S 291

Same as S 290 yet nickel plated.



▶ S 296

Heavy duty high tensile feedwheel tensioner for steel strapping 3/8" - 3/4" x 0.035". Good for flat packages.



◀ S 298

Standard-duty feedwheel tensioner with a stronger and longer handle for enhanced performance. 3/4" - 1-1/4" x 0.035 steel strapping. 19mm to 32mm width, up to 0.9mm thickness. Applications: Ideal for flat packages.



17.5 mm



Tension the strap



Place the seal



Close the seal

► **YS 1200**

Compact feedwheel tensioner for steel strap 3/8" - 3/4" x 0.023".



◀ **YS 1300**

Feedwheel tensioner for steel strap 3/8" - 3/4" x 0.025".



► **YS 1400**

Compact heavy-duty feedwheel tensioner for demanding applications. 3/4" - 1-1/4" x 0.035 steel strapping. 19mm to 32mm width, up to 0.9mm thickness. Applications: Ideal for flat packages.



26mm

◀ **S 350**

Heavy-duty feedwheel tensioner designed for high-tensile steel strapping. 3/4" - 1-1/4" x 0.035 steel strapping. 19mm to 32mm width, up to 0.9mm thickness. Applications: Ideal for flat packages.



► **S 300**

Heavy duty windlass tensioner for steel strapping 3/4" - 1-1/4" x 0.028" - 0.044".



Tension the strap



Apply more tension to the strap when needed



Close the seal

► **C 3103**
C 3104
C 3105
C 3106



VIDEO

Double notched 11" handle steel strapping sealer. Whole tool is heat-treated.

- C 3103: 3/8". Use with CS 041 open seal or closed seal.
- C 3104: 1/2". Use with CS 051 open seal or closed seal.
- C 3105: 5/8". Use with CS 051 open seal or closed seal.
- C 3106: 3/4". Use with CS 061 open seal or closed seal.



◀ **C 3123**
C 3124
C 3125
C 3126



VIDEO

Double notched 14" handle labor saving steel strapping sealer. Whole tool is heat-treated.

- C 3123: 3/8". Use with CS 041 open seal or closed seal.
- C 3124: 1/2". Use with CS 051 open seal or closed seal.
- C 3125: 5/8". Use with CS 051 open seal or closed seal.
- C 3126: 3/4". Use with CS 061 open seal or closed seal.

► **C 3154**
C 3155
C 3156



VIDEO

Single notched high tensile 11" handle steel strapping sealer. Whole tool is heat-treated.

- C 3154: 1/2". Use with closed seal.
- C 3155: 5/8". Use with closed seal.
- C 3156: 3/4". Use with closed seal.



◀ **C 3203**
C 3204
C 3205
C 3206



VIDEO

Double notched 13.5" handle steel strapping sealer. Whole tool is heat-treated.

- C 3203: 3/8". Use with CS 041 open seal or closed seal.
- C 3204: 1/2". Use with CS 051 open seal or closed seal.
- C 3205: 5/8". Use with CS 051 open seal or closed seal.
- C 3206: 3/4". Use with CS 061 open seal or closed seal.

► **C 3226**



VIDEO

3/4" heavy duty double notched 17" handle steel strapping sealer. Whole tool is heat-treated. Use with CS 061 open seal or CS 20 / CS 21 / CS22 closed seal.



◀ **C 3160**
C 3166
C 3180



VIDEO

Double notched side action steel strapping sealer with aluminum pipe handle. (Handle length 25.5")

- C 3160 for steel strapping 3/4" and thickness from 0.025" up. Use with CS 061 open seal or CS 20 / CS 21 / CS 22 closed seal.
- C 3166 for steel strapping 1" x 0.035". Use with CS 28 closed seal.
- C 3180 for steel strapping 1-1/4" x 0.035". Use with CS 28 closed seal.

► **YC 3100**
YC 3110
YC 3120

Double notch up cut side action heavy duty steel strap sealer.

- YC 3100: 3/4" x 0.025"-0.031".
- YC 3110: 1-1/4" x 0.025"-0.031".
- YC3120 : 1-1/4" x 0.025"-0.047".



◀ **C 3170**
C 3171
C 3173



VIDEO

Single down cut side action steel strapping sealer with steel pipe handle. (Handle length 27").

- C 3170 for steel strapping 3/4". Use with CS 061 open seal or CS 20 / CS 21 / CS 22 closed seal.
- C 3171 for steel strapping 1" x 0.035". Use with closed seal.
- C 3173 for steel strapping 1-1/4" x 0.035". Use with CS 28 closed seal.

► **CS 041**
CS 051
CS 061

Open seals (snap-on seals) for steel strapping.
25mm long and 0.6mm thick.

- CS 041 for 1/2" straps. Use with C3104 / C3124 / C3204.
- CS 051 for 5/8" straps. Use with C3105 / C3125 / C3205.
- CS 061 for 3/4" straps. Use with C3106 / C3126 / C3206 / C3226.



◄ **CS 15**

Seals for steel strapping combination tool.

- CS 15: 5/8"

► **CS 22**

3/4" closed seal for steel strapping.
Use with C 3226/ C 3160/ C3170/ YC3100.
• CS 22: 57mm x 0.8mm.



◄ **CS 28**

1-1/4" closed seal for steel strapping.
50mm long x thickness 0.9mm.
Use with C 3173/ C 3180/ YC3110/ YC3120.



◄ **H 100**

Carbon steel drop forged cutter for 3/8" - 3/4" x 0.035" steel strap. Spring design to reduce operation fatigue.



VIDEO

► **H 101**

Same as H100 and with magic tie for safety storage.



VIDEO



Blades are sharp so it is even easy to cut soft material such as PP strap.



◄ **H 200**

Same as H201 but without yellow PVC grips.





◀ H 201

Carbon steel drop forged cutter with wide blades and yellow PVC grips.
For steel strapping 3/8" ~ 1-1/4" x 0.035"



VIDEO



Our blades are made so precisely and sharp so the cutter can cut soft material such as PP strap. Never worry about the strap been stuck or jammed between blades.



Before and after CNC processing



◀ H 230

Heavy duty steel strap cutter with wide blades for 3/8" ~ 1-1/4" x 0.035". "SAE 4140" high carbon steel drop forged.



◀ H 240

Regular duty cutter for 3/8" ~ 1-1/4" x 0.035" steel, PP and PET strap. Sheet metal handles is lighter but durable. Weighs only 0.6 kgs.



VIDEO



◀ H 268

Cutter with safety function which holds excess end strap when cut the strap.
For 3/8" ~ 1-1/4" x 0.035" straps.

▶ H 263



VIDEO

Cutter with rubber pads gently releases the straps after cutting.
For steel strapping 3/8" ~ 1-1/4" x 0.035".



Rubber pads hold the strap firmly when cutting the strap and they also can avoid sudden release of strap after cutting.



▶ H 2635



VIDEO

STEEL STRAPPING CUTTER
Suitable for steel strapping
1/2" ~ 1-1/4" x 0.035".



1. Safety Cutter with Rubber Pads
The rubber pad presses down on the steel strap to prevent it from springing out and causing injury when cut.

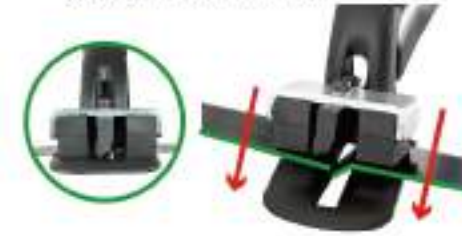

2. Effortless Cutting
Long-handle cutters reduce effort and let you reach farther, hard-to-cut areas with ease.



3. Curved Grip
MoreSpace, Less Interference





◀ **H 300**

High carbon steel drop forged strap cutter for straps up to 2" x 0.035".

▶ **H 302**

High carbon steel drop forged cutter with hammer knob for strap up to 2" x 0.035".



Hammer knob handle

Anti-flapping plate blocks strap during and after cutting.



Lock Nuts to avoid loosening. Increase life time.

Sharp and narrow blade makes it easy to insert the blade under the tightened strap.

▶ **H 305**

SAE 4140 high carbon steel drop forged heavy duty steel strap cutter for straps up to 2" x 0.05".

Whole tool is bake painted after assembled. The paint can protect against rust.



VIDEO



◀ **H 306**

Heavy duty steel strap cutter for straps up to 2" x 0.050".

▶ **H 307**



VIDEO

Same as H306 but with hammer handle which allows the user to push the blade easily in between the strap and package. No more twist that damage the blade, strap and/or the package.



Hammer the blade to squeeze it in between the strap and package.



No more twist that damage the blade, strap and/or the package.

▶ **H 410**



VIDEO

High carbon steel drop forged strap cutter for straps up to 2" x 0.05". Blade can be reverse when dull.



Benefits to have a strap chopper in premises.

Space Saving

Less space to store garbage(used straps).

Costs Saving

Handling or transporting scraps is usually charged by volume or weight. Shredded scraps are a lot smaller in size and therefore, reduce the costs of recycling.

Workplace Safety

Reduce tripping risks. Your workspace looks professional and clean.

Sustainability

Shredded straps can be used to process again into PP or PET strap. Give a new life to the scraps. Reduce the amount of producing new material = CO2 reduction.



MODELS		PM101U	PM101E
Item		SPECIFICATIONS	
Compatible Strapping Materials & Capacity		PP strap without clip: 5/8"(W) x 0.031"(T) PET strap without clip: 1"(W) x 0.05"(T) Steel strap without clip: 3/4"(W) x 0.039"(T)	PP strap without clip: 16mm(W) x 0.8mm(T) PET strap without clip: 25mm(W) x 1.3mm (T) Steel strap without clip: 19mm(W) x 1mm(T)
Power	Feed Power	AC motor 1HP/750W 110VAC 50/60 Hz · 11 A · 1410/1690RPM	AC motor 1HP/750W 230VAC 50/60 Hz · 5.5 A · 1410/1690RPM
	Cutting Power		
Number of Rotating Knives		1-blade rotary cutter	
Knife Life Time		Knife can be rotated 2 times for extended life	
Cut Length		3" ± 0.2"	80 mm ± 5 mm
Infeed Speed (per strip)		50Hz: 230±20 FPM (feet/minute) 60Hz: 295±20 FPM (feet/minute)	50Hz: 70±5 MPM (meters/minute) 60Hz: 90±5 MPM (meters/minute)
Safety Standard		Hearing protectors are recommended	
Overall Dimensions (Stand not included) L x W x H		27.56" x 19.69" x 21.65"	700 x 500 x 550mm
Machine Weight (Stand not included)		198.4 lbs	90kg
Noise Level		<80 dB(No loading)	

Find the Right Dispenser

STEEL STRAP COIL WINDING

Ribbon Wound: The steel strapping is wound onto itself so that the width of the coil is the same as the strap.

Oscillated/Mill Wound: The steel strapping is wound across a width of the coil. The width of the strap is smaller than the coil.

HOW TO PICK THE RIGHT DISPENSER?

1. Obtain the core size, face coil and outer diameter (O-D) of the strap coil you are using. (And ribbon wound or oscillated/mill wound if you wanted to use for steel strap)
2. Check our table and eliminate those don't fit your strap spec.
3. Find your preferable handle type (single bar or trolley type), disc type (metal, plastic, or no disc), break design (regular, troller or economy brake), wheel size and type.
4. Done! You've got the right dispenser!

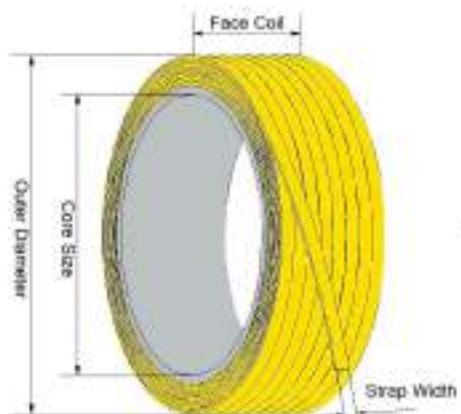

← STRAP ROLL



▲ **OSCILLATED MILL COIL**

The steel strapping is wound across a width of the coil. The width of the strap is smaller than the coil.



▲ **RIBBON WOUND**

The steel strapping is wound onto itself so that the width of the coil is the same as the strap.



Single Bar



Trolley Type



Water leaking design



Plastic Disc



Metal Disc



No Disc



Regular Brake



Trolley Brake



Economy Brake



Plastic Wheel



Rubber Wheel w / Steel Center



No Wheel

Floor Stand Type for Cord Strap



▲ CA 330 / CA 332



▲ CA 340



▲ CB 330



▲ CB 333



▲ CB 335



▲ CA 365

ITEM NO	CORE SIZE (mm)	MAX. STRAP WIDTH (mm)	MAX. FACE COIL (mm)	DISC OUTER DIA. (mm)	COIL WINDING	WHEEL TYPE	ASSEMBLED
CA 330	62 & 75	38	160	Metal 300	R/O	No	Semi
CA 332	62 & 75	38	160	Metal 300	R/O	No	Not assembled
CA 340	62 & 75	51	150	Metal 300	R/O	No	Semi
CB 330	75	38	150		R/O	No	Semi
CB 333	75	40	150	450	O	No	Semi
CB 335	75	51	150	330	O	No	Semi
CA 365	62 & 75	40	140~200	Plastic 495	O	No	Semi

--Coil Winding: R means Ribbon coil. O means Oscillated/Mill coil

Dispenser with Wheels for Cord Strap



▲ CA 327H
(Without lacing rod holder.)



▲ CA 2481HS
(With lacing rod holder. Lacing rod not included.)



▲ CA 322H / CA 323H
(With lacing rod holder. Lacing rod not included.)



ITEM NO	CORE SIZE (mm)	MAX. STRAP WIDTH (mm)	MAX. FACE COIL (mm)	DISC OUTER DIA. (mm)	COIL WINDING	WHEEL TYPE	ASSEMBLED
CA 2481HS	62 & 75	40	150	Metal 495	R/O	6" rubber w / steel center	Semi
CA 322H	62 & 75	40	150	Metal 300	R/O	6" plastic	Semi
CA 323H	62 & 75	40	150	Plastic 495	R/O	6" plastic	Semi
CA 327H	62 & 75	40	160	Metal 300	R/O	6" plastic	Semi

--Coil Winding: R means Ribbon coil. O means Oscillated/Mill coil

Dispenser with Wheels for Cord Strap



▲ CA 255HS



▲ CB 326



▲ CB 327H



▲ CA 665



▲ CA 790

ITEM NO	CORE SIZE (mm)	MAX. STRAP WIDTH (mm)	MAX. FACE COIL (mm)	DISC OUTER DIA. (mm)	COIL WINDING	WHEEL TYPE	ASSEMBLED
CA 255HS	over 25.4	40	107	Metal 400	R/O	6" rubber w/ steel center	Semi
CB 326	75	40	150	530	R/O	6" plastic	Semi
CB 327H	75	40	160	590	R/O	6" plastic	Semi
CA 665	62 & 75	40	140~200	Plastic 495	O	6" plastic	Semi
CA 790	75	40	160		R/O	6" plastic	Semi

** Coil Winding: R means Ribbon coil. O means Oscillated/Mill coil

Floor Stand Type for PP or Cord Strap

▶ CA 350 / CA352 / CA354



◀ CA 353



▶ CA 360



ITEM NO	CORE SIZE (mm)	MAX. STRAP WIDTH (mm)	MAX. FACE COIL (mm)	DISC OUTER DIA. (mm)	COIL WINDING	WHEEL TYPE	ASSEMBLED
CA 350	200	38	160	Metal 495	O	No	Semi
CA 352	200	38	160	Plastic 495	O	No	Semi
CA 354	200	38	190	Plastic 495	O	No	Semi
CA 353	200	38	160	Plastic 495	O	No	Semi
CA 360	200 & 280	40	140~200	Plastic 495	O	No	Semi

** Coil Winding: R means Ribbon coil. O means Oscillated/Mill coil



▲ CA 100H / CA 100HS
CA 113H / CA 200H



▲ CA 120HS / CA 124HS



▲ CA 249H
(With lacing rod holder.)



▲ CA 253HS



▲ CA 240H  VIDEO



▲ CA 242H / CA 242HS  VIDEO



▲ CA 271H



▲ CA 276



▲ CA 2761



▲ CA 2764



▲ CA 2766

ITEM NO	CORE SIZE (mm)	MAX. STRAP WIDTH (mm)	MAX. FACE COIL (mm)	DISC OUTER DIA. (mm)	COIL WINDING	WHEEL TYPE	ASSEMBLED
CA 100H	200 and 400	40	200	Metal 610	R/O	6" plastic	Semi
CA 100HS	200 and 400	40	200	Metal 610	R/O	6" rubber w/ steel center	Semi
CA 113H	400	40	200	Metal 635	O	5" plastic	Semi
CA 200H	200 and 280	40	200	Metal 500	R/O	6" plastic	Semi
CA 120HS	150, 200, 280 and 400	40	200	Metal 616	R/O	6" rubber w/ steel center	Semi
CA 124HS	140, 200, 280 and 400	40	200	Metal 616	R/O	6" rubber w/ steel center	Semi
CA 240H	200	40	190	Plastic 495	O	6" plastic	Semi
CA 242H	200	40	190	Metal 495	O	6" plastic	Semi
CA 242HS	200	40	190	Metal 495	O	6" rubber w/ steel center	Semi
CA 271H	200	40	180	Plastic 495	O	6" plastic	Semi

** Coil Winding: R means Ribbon coil. O means Oscillated/Mill coil

ITEM NO	CORE SIZE (mm)	MAX. STRAP WIDTH (mm)	MAX. FACE COIL (mm)	DISC OUTER DIA. (mm)	COIL WINDING	WHEEL TYPE	ASSEMBLED
CA 249H	200	40	200	Plastic 495	O	6" plastic	Semi
CA 253HS	150, 200 & 280	40	200	Metal 500	R/O	6" rubber w/ steel center	Semi
CA276	200	51	230	Metal 450	O	6" plastic	Semi
CA2761	75	40	200	Metal 450	R/O	6" plastic Wheel with washer & screw	Semi
CA2764	200	51	230	Metal 450	O	6" plastic Wheel with washer & screw	Semi
CA2766	200	51	230	Metal 480	O	6" plastic	Semi

** Coil Winding: R means Ribbon coil. O means Oscillated/Mill coil



▲ CA 324H / CA 3243HS / CA 326H



▶ CA 660
(With lacing rod holder.)



▲ CA 757

ITEM NO	CORE SIZE (mm)	MAX. STRAP WIDTH (mm)	MAX. FACE COIL (mm)	DISC OUTER DIA. (mm)	COIL WINDING	WHEEL TYPE	ASSEMBLED
CA 324H	200	40	200	Metal 500	O	6" plastic	Semi
CA 3243HS	200	40	200	Metal 500	O	8" rubber w/ steel center	Semi
CA 326H	200	40	200	Plastic 495	O	6" plastic	Semi
CA 660	200 & 280	40	140~200	Plastic 495	O	6" plastic	Semi
CA 757	150, 200, 280 & 400	51	200	Metal 610	R/O	6" plastic	Semi

** Coil Winding: R means Ribbon coil. O means Oscillated/Mill coil



▲ CA 400HS / CA 410HS
CA 420HS / CA 430HS



▲ CA 500HS



▲ CA 505HS / CA 5061HS / CA 507HS



▲ CA 470



▲ CA 5053

ITEM NO	CORE SIZE (mm)	MAX. STRAP WIDTH (mm)	MAX. FACE COIL (mm)	DISC OUTER DIA. (mm)	COIL WINDING	WHEEL TYPE	ASSEMBLED
CA 400HS	400	51	90	Metal 710	O	8" rubber w/ steel center	Fully
CA 410HS	400	51	180	Metal 710	O	8" rubber w/ steel center	Fully
CA 420HS	400	51	90	Metal 710	O	8" rubber w/ steel center	Semi
CA 430HS	400	51	200	Metal 710	O	8" rubber w/ steel center	Semi
CA 470	400	51	90	Metal 710	O	16" air	Semi
CA 500HS	400	32	90	Metal 635	O	8" rubber w/ steel center	Semi
CA 505HS	400	32	200	Metal 635	O	8" rubber w/ steel center	Semi
CA 5061HS	400	32	200	Metal 635	O	10" rubber w/ steel center	Semi
CA 507HS	200 & 400	32	200	Metal 610	O	8" rubber w/ steel center	Semi
CA 5053	400	32	90	Metal 635	R(only for 32mm wide)/O	8" plastic	Semi

** Coil Winding: R means Ribbon coil. O means Oscillated/Mill coil



CA 540H / CA 540HS / CA 543HS
CA 550H / CA 550HS



CA 547HS



CA 700HS



CA 610B



CA 620B



CA 720HS



CB 720HS

Wider tool tray ideal for pneumatic or battery tool.



CA 650HS / CA 652HS
CA 6521HS / CA 653 HS
CA 654HS / CA 655HS



CA 670HS

ITEM NO	CORE SIZE (mm)	MAX. STRAP WIDTH (mm)	MAX. FACE COIL (mm)	DISC OUTER DIA. (mm)	COIL WINDING	WHEEL TYPE	ASSEMBLED
CA 540H	200 and 400	40	200	Metal 610	R/O	8" plastic	Semi
CA 540HS	200 and 400	40	200	Metal 610	R/O	8" rubber w/ steel center	Semi
CA 543HS	400	40	200	Metal 635	O	8" rubber w/ steel center	Semi
CA 550H	200 and 280	40	200	Metal 500	R/O	8" plastic	Semi
CA 550HS	200 and 280	40	200	Metal 500	R/O	8" rubber w/ steel center	Semi
CA 547HS	75, 150, 200 and 280	40	200	Metal 500	R/O	8" rubber w/ steel center	Semi
CA 700HS	200 and 400	40	200	Metal 610	R/O	10" rubber w/ steel center	Semi
CA 720HS	400	40	200	Metal 635	O	10" rubber w/ steel center	Semi
CB 720HS	400	40	200	Metal 635	O	8" rubber w/ steel center	Semi

** Coil Winding: R means Ribbon coil, O means Oscillated/Mill coil

ITEM NO	MAX. STRAP WIDTH (mm)	DISC OUTER DIA. (mm)	COIL WINDING	WHEEL TYPE	ASSEMBLED
CA 610B	19 mm x 1 coil	520	R	4" plastic	Semi
CA 620B	19 mm x 1 coil	520	R	No	Semi
CA 650HS	19 mm x 1 coil	Metal 620	R	8" rubber w/ steel center	Semi
CA 652HS	19 mm x 2 coils	Metal 620	R	8" rubber w/ steel center	Semi
CA 6521HS	16 mm x 2 coils	Metal 620	R	10" rubber w/ steel center	Semi
CA 653HS	32 mm x 1 coil	Metal 620	R	8" rubber w/ steel center	Semi
CA 654HS	19 mm x 1 coil and 32 mm x 1 coil	Metal 620	R	8" rubber w/ steel center	Semi
CA 655HS	51 mm x 1 coil	Metal 620	R	8" rubber w/ steel center	Semi
CA 670HS	51mm		R	10" rubber w/ steel center	Fully

** Coil Winding: R means Ribbon coil, O means Oscillated/Mill coil



CA 741HS



CA 764H / CA 764HS



CA 760HS



VIDEO



CA 851

Round tube trolley handle.

Solid Rubber Wheel



CA 920

Multi-function storage dispenser.



VIDEO

ITEM NO	CORE SIZE (mm)	MAX. STRAP WIDTH (mm)	MAX. FACE COIL (mm)	DISC OUTER DIA. (mm)	COIL WINDING	WHEEL TYPE	ASSEMBLED
CA 741HS	140, 200, 280 and 400	40	200	Metal 616	R/O	10" rubber w/ steel center	Semi
CA 760HS	400	51	200	Metal 616	O	10" rubber w/ steel center	Semi
CA 764H	150, 200, 280 and 400	51	200	Metal 616	R/O	10" plastic	Semi
CA 764HS	150, 200, 280 and 400	51	200	Metal 616	R/O	10" rubber w/ steel center	Semi
CA 851	400	43	160	Metal 650	O	10" solid	Semi

** Coil Winding: R means Ribbon coil. O means Oscillated/Mill coil



◀ **LR100**
130cm long lacing rod.



▶ **LR 300**
A probe head that works for any standard 3/4" broom handle. Good for strap up to 2". Broom not included.



BROOM



◀ **LR 310**
165cm long pallet probe.



▶ **LR403 Pallet Threading Tool**

High-impact nylon tool with fiberglass rod & flexible cleat, speeds up pallet strapping, ensures stable strap guidance, and reduces awkward bending.

Works with **PP, PET, woven, and steel** straps. **Magnet** at handle for easy storage.

Max. Strap Width : 25 mm
Thickness : 0.5 ~ 3 mm

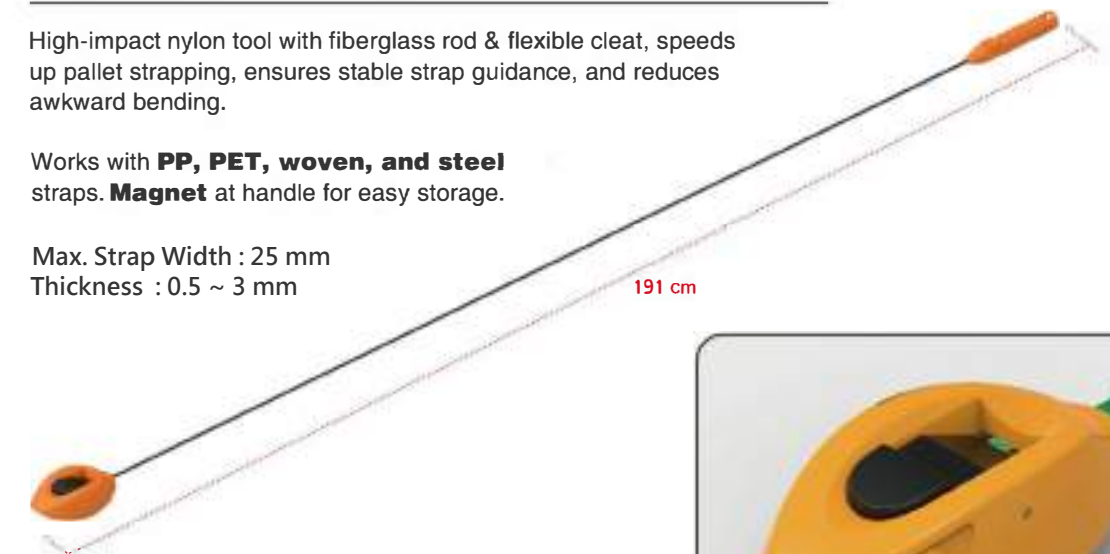

191 cm



CA863 Drop-in Strapping Dispenser

**Compatible**

One for core sizes min. 200 or above.
Buy smart. One for all sizes.

**Considerate**

Big tool Tray, big storage.
Good for battery/pneumatic tools.

**Rapid**

Slide the strap coil in.
Replace the strappings in seconds.



VIDEO

**Safety**

Reduce risks of bending
or twisting when lifting.

**Compatible**

One for core sizes min. 200 or above.

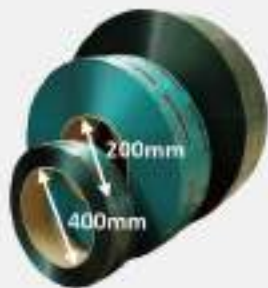
**High Efficiency**

Slide the strap coil in.

**Big Tool Tray**

More storage space where customers
need it most.

**Solid Wheel**

Durable and suitable for wet, uneven
or rough road.

**Ergonomic Handle**

Comfortable trolley type design.
Adjustable handle to fit user's height.

**Safety Hook**

Store excess strap in place when not using.



ITEM NO	CORE SIZE (mm)	MAX. STRAP WIDTH (mm)	MAX. FACE COIL (mm)	DISC OUTER DIA. (mm)	COIL WINDING	WHEEL TYPE	ASSEMBLED
CA 863H	min. 200 or above	51	19~200	650	R/O	10" solid	Semi

-- Coil Winding: R means Ribbon coil. O means Oscillated/Mill coil

▶ CA 872 Tool Balancer Dispenser

(Tool balancer not included)

- Hang and hold the tool to minimize operator effort during the use of the tool.
- Designed to withstand tool weight max. 15 kgs.
- Good for plastic and steel strapping coil that has 200 mm (8") or 400mm (16") inner core.
- Load strap coil while keeping the dispenser in upright position.
- Big tool tray 450 x 220 x 130mm.
- One storage pin behind the tool tray to hold warehouse accessories such as pens, rulers, knives, stretch wrap roll, etc.
- Lacing rod holder included.
- Casters with brake.
- One hanging bar above tool tray to keep label or tape rolls.
- Dispenser Size: Max. 120 x 55 x 220cm. 42 kgs.

1. TOOL TRAY

Big enough to store battery
or pneumatic tool.

2. CASTER

Casters with brake

3. STORAGE BIN

Put pen / pencil /
knife, etc

**5. LANCING ROD HOLDER**

Keep the pallet probe.
Pallet probe sold separately.

**4. WHEEL**

Heavy duty 10" wheels



VIDEO

ITEM NO	CORE SIZE (mm)	MAX. STRAP WIDTH (mm)	MAX. FACE COIL (mm)	DISC OUTER DIA. (mm)	COIL WINDING	WHEEL TYPE	ASSEMBLED
CA 872	200 & 400	40	200	610	R/O	10" rubber w/steel center	Semi

-- Coil Winding: R means Ribbon coil. O means Oscillated/Mill coil

▼ CA 874

- Combines tool-hanging support and drop-in strap loading design for improved efficiency
- Allows easy strap coil installation without laying down the dispenser
- Designed to reduce operator effort during strapping operations
- Multiple storage solutions to keep tools and accessories well organized
- Stable wheeled base with brake for easy movement and secure positioning
- Suitable for both plastic and steel strapping applications



► CA 871

CA871 is a simplified version of CA872, retaining the versatile storage features but without the tool balancer.

Its streamlined structure offers greater flexibility and ease of use, making it ideal for packaging environments that require efficient tool organization while helping to improve operational efficiency and reduce operator fatigue.



► CA 875

CA875 features a redesigned drop-in strap loading orientation, offering greater adaptability to different workstation layouts.

This configuration supports smoother strap replacement, enhances operational flow, and provides added flexibility for a wide range of packaging applications.



ITEM NO	CORE SIZE (mm)	MAX. STRAP WIDTH (mm)	MAX. FACE COIL (mm)	DISC OUTER DIA. (mm)	COIL WINDING	WHEEL TYPE	ASSEMBLED
CA 874	min. 200 or above	51	19 ~ 200	650	R/O	10" rubber w/steel center	Semi
CA 871	200 & 400	40	200	610	R/O	10" rubber w/steel center	Semi
CA 875	min. 200 or above	51	19 ~ 200	650	R/O	10" rubber w/steel center	Semi

▼ CD 200
Pallet Strap Dispenser

- Deliver 2 straps at the same time to the other side of pallet.
- Dispenser can be adjusted to different pallet height.
- Easy storage to a smaller size. Lift and move forks toward the dispenser. It clicks to the magnets on dispenser. Unlock the slide latches to lay the upper arm down.
- Big tool tray 450 x 220 x 130mm.
- Casters with brake.
- Dispenser Weight: 96 kgs.



ITEM NO	CORE SIZE (mm)	MAX. STRAP WIDTH (mm)	MAX. FACE COIL (mm)	DISC OUTER DIA. (mm)	COIL WINDING	WHEEL TYPE	ASSEMBLED
CD 200	150, 200, 280 & 400	40	200	616	O	10" solid wheels	Semi

-- Coil Winding: R means Ribbon coil. O means Oscillated/Mill coil

▼ CD 203



		CD200	CD203 (with height extension kit)
H: Applicable strapping height	Minimum	109 cm	160 cm
	Maximum	178 cm	215cm
W1: Applicable Pallet Width (Fork Opening Width)	Maximum	120 cm	
H1: Applicable Pallet Fork Height	Minimum	7 cm or higher (From ground level)	



► **S 210**



VIDEO

Push bar tensioner with breaker nose to cut the strap.
For 3/8" - 3/4" x 0.02" max. stainless steel banding.



◄ **S 223**



VIDEO

Tensioner with cutter and hammer function.
For stainless steel strap up to 3/4".



► **S 225**

Rack tensioner with duckwork and built-in cutter for 3/8" - 3/4"
stainless steel banding.
Use with CS 34 / CS 35 / CS 36 / CS 53 / CS 54 / CS 55 / CS 56.





◀ S 240



VIDEO

Durable tensioner with cutter & hammer knob for binding irregular & non-compressible packages.

For stainless steel bands 3/8" ~ 3/4" x 0.03" max. Use with CS 34/ CS 35/ CS 36/ CS 53/ CS 54/ CS 55/ CS 56 seal.



▶ S 244

Tensioner with built-in cutter. For stainless steel strap up to 3/4". (3/8"-3/4")
Max. 0.025" (0.63mm) thick.
Product Size: 80mm* 80mm*85mm
Tool can be adjusted to 3 different operations for single or two-handed tensioning.
Good for working in tight areas.



◀ S 260

Drop forged banding tool with built-in cutter for stainless steel bands 3/8" ~ 3/4" x 0.03" max. Product Size: 235 * 100 * 75mm
Essential parts are heat-treated.
Specially designed holding dog to work with tough and hard stainless steel banding in the market.
Use with CS34 / CS35 / CS36 / CS53 / CS54 / CS55 / CS56 seal.

▶ S 262



VIDEO

Same as S260 except all parts are heat-treated.



▼ S 271

Same as S 262 but for bands 3/4" ~ 1-1/4" x 0.044" max. Product Size: 390 x 290 x 80 mm
Use with CS 36/ CS 56 / CS 59 seal.





- ▶ **CS 34**
- CS 35**
- CS 36**

Stainless steel type 304.

- CS 34 for 1/2" straps. Use with S225/S226/S227/S246/S240/S260/S262.
- CS 35 for 5/8" straps. Use with S225/S226/S227/S246/S259/S240/S260/S262.
- CS 36 for 3/4" straps. Use with S225/S226/S227/S246/S259/S249/S240/S260/S262/S271.



Stainless steel banding coil not included.



- ▶ **CS 53**
- CS 54**
- CS 55**
- CS 56**
- CS 59**

Stainless steel type 304.

- CS 53 for 3/8" straps. Use with S225/S226/S227/S246/S240/S260/S262/S278.
- CS 54 for 1/2" straps. Use with S225/S226/S227/S246/S240/S260/S262.
- CS 55 for 5/8" straps. Use with S225/S226/S227/S246/S259/S240/S260/S262.
- CS 56 for 3/4" straps. Use with S225/S226/S227/S246/S259/S249/S240/S260/S262/S271.
- CS 59 for 1-1/4" straps. Use with S227/S259/S249/S271.



SB 100

3" core insert for plastic tote.



SB 104 / SB 106

Plastic tote for plastic/steel strapping and stainless steel banding.
SB 104 for 1/2".
SB 106 for 5/8" and 3/4".



SB 1041 / SB 1061

Plastic tote with 3" core insert installed.
SB 1041 for 1/2".
SB 1061 for 5/8" and 3/4".

SB 210



VIDEO

Fold stainless steel band straight and flat. Reduce fatigue and also increase safety to workers. Available for bands up to 3/4"



▶ **RV 100**

Rivet installation tool. Use to mount plastic rivets in pre-punched or drilled holes.

◀ **H 101**

Carbon steel drop forged cutter for 3/8" - 3/4" x 0.035" stainless steel banding.

▶ **H 201**

Best selling carbon steel drop forged cutter with wide blades and yellow PVC grips. For stainless steel banding 3/8" - 1-1/4" x 0.035".

◀ **H 230**

Heavy duty cutter with wide blades for 3/8" - 1-1/4" x 0.035" stainless steel banding. Drop forged "SAE 4140" high carbon steel.

▶ **S 278**

Tensioner with built-in cutter for 1/4" - 3/8" ball lock clamps and CV boot clamps.

◀ **S 283**

Light-duty tensioner with duck work. Use for clamps width up to 8mm x 0.6mm. Use with ball lock clamps.

▶ **S 284**

Stainless steel banding tie gun with adjustable bundling pressure function and rubber handle. Fasten and cut ties automatically. For stainless steel ball lock clamps up to 0.3mm thick and 7.9mm wide.

◀ **S 285**

Stainless steel banding tool for clamps width up to 10mm x 0.4mm. To tighten and cut band with one hand. Use with ball lock clamps.



VIDEO



◀ **S 264**

Adapter kit for S268 and S272 when the clamp is 3/8" wide.



◀ **S 268**

Tightens clamp to desired tension and seals the clamp by striking the punch with a hammer. Good for 5/8" clamp. Use with S264 when the clamp is 3/8" wide.



▶ **S 272**

Tightens clamp to desired tension and seals the clamp by striking the punch with a hammer. Good for 5/8" clamp. Use with S264 when the clamp is 3/8" wide.



▶ **CT 400**

Metal construction. Cut plastic ties up to 5mm wide.



▶ **CT 2831**

Tying tool with manual cutter. Designed for Deltec strap or other self-locking nylon strap. Cut strap without sharp edges. For strap up to 13mm wide and 2.5mm thick.

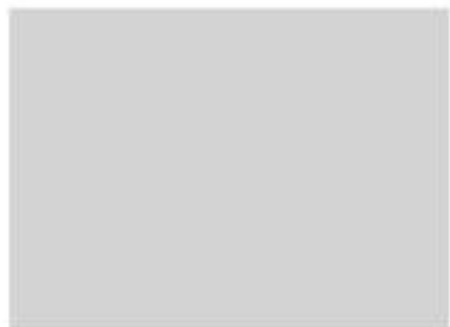

Surface Protection



◀ **TH 120**

Painter masking film/paper dispenser with 14" wide blade.



VIDEO



◀ **TF 400**
TF 415

Window film applicator.
TF 400 for 12" wide.
TF 415 can be adjusted to 21" and 24" wide.



▶ **TF 570**

Carpet film applicator.
TF 570 for 24", 36" and 48" wide.



◀ **TF 572**

Carpet film applicator.
TF 572 for 24", 36" and 48" wide.



Aluminum Profile Tape Dispenser



Rapid

Save time. Save money. 4 times faster than applying tape by hands.



Clean Cut

Easy cut and perfect finish.



Align

Guiding and taping at straight line.



Safety

Eliminate finger cutting and keep you safe at work.

Work smart and rapid

Taping by hand is never easy. This tool can standardize (get the same result every time even with different users) and increase the productivity.



Aligning tape in straight line

Glide the dispenser with the front guide over the surface. Ensure the tape is constantly contact with the profile and keep the tape close to the edge of profile until reaching the end.



Blade sharp but safe

Blade comes out and cuts forward. No risks of scratching the product's surface. Blade cover keeps the fingers from exposed blade.



Tension knob

Adjustable tension control to adapt for a variety of tapes.



Ergonomic handle & Trigger

Ergo-friendly comfort grip for long-lasting use. Trigger-activated cutter blade for easy operation.



Logo can be molded on the handle to increase brand recognition.

Auxiliary handle

An auxiliary handle can be mounted to apply constant pressure on tape for better bonding.



ITEM NO	Photo	Tape Core	Tape Width	Tape OD.
TH 532		76mm	up to 76mm width.	up to 200mm.
TH 5321		78mm		

► T378

Taping joists is never easy. The first tool in the world to do more with less efforts. One tool that centers, tapes and cuts. This dispenser works with tape that has width 48-50mm and max outer diameter 150mm.



Fast

Apply tape 3 to 4 times faster than using bare hands.

Easy

Center tape on the timber easily with side guiding plates. Rubber roller offers consistent pressure to the tape and therefore give good adhesion to the joist. Equipped with case hardened sharp blade.



Work safer and comfortable

No need to press tape with hand. Keep you from getting splinters in your hands. Adjustable handle tailored to joists with different height. Less discomfort of body bending and muscle strains.



Multiple settings

Side guiding plates can be set fixed or free to different needs.





W 100



W 110



W 1102



W 115



W 1152



W 111



W 113



W 1133



W 117



W 1172

ITEM NO	Core Size (Inch)	Film Width (Inch)	Handle	Features
W 100	2, 3	12-20	Foam	Aluminum base and cover.
W 110	1-1/2, 2, 3	12-20	Foam	Aluminum base and cover.
W 1102	1-1/2, 2, 3	12-20	Foam	Aluminum base and cover. Foam grip for a soft touch. A rubber pad base secures the dispenser upright.
W 111	1-1/2, 2, 3	12-20	PVC	Aluminum base and cover.
W 113	3	12-20	PVC	Ball bearing between plastic bottom plate & aluminum base to give greater flexibility.
W 1133	3	12-20	PVC	Nylon top cover. Ball bearing between plastic bottom plate & aluminum base to give greater flexibility.

ITEM NO	Core Size (Inch)	Film Width (Inch)	Handle	Features
W 115	3	12-20	Foam	Aluminum base and cover. Foam grip for a soft touch. A rubber pad base secures the dispenser upright.
W 1152	3	12-20	Neoprene	Aluminum base and cover. Durable neoprene grip not easy to crack after use. A rubber pad base secures the dispenser upright.
W 117	3	12-20	Foam	Aluminum base and cover. Foam grip for a soft touch. A rubber pad base secures the dispenser upright.
W 1172	3	12-20	Neoprene	Aluminum base and cover. Durable neoprene grip not easy to crack after use. A rubber pad base secures the dispenser upright.



W 240 / W 241



W 2422



W 2426



VIDEO



W 242



W 2424



VIDEO



W 300



W 310



W 410

ITEM NO	Core Size (Inch)	Film Width (Inch)	Max. OD for film (mm)	Handle	Features
W 240	2	18-21		PVC	Steel frame, aluminum bottom and top cover.
W 241	2	17-20		PVC	Steel frame, aluminum bottom and top cover.
W 242	2	16-20	180		Aluminum frame.
W 2422	2	16-20	180		Aluminum frame with stand.
W 2424	2	16-20	140		Aluminum frame with stand. Light-weight film dispenser with magnets.
W 2426	2	16-20	140		Aluminum frame. Light-weight film dispenser with magnets.

ITEM NO	Core Size (Inch)	Film Width (Inch)	Handle	Features
W 300	2, 3	12-20	Foam	Zinc base, aluminum bottom and top cover.
W 310	1-1/2, 2, 3		Foam	Zinc base, aluminum bottom and top cover.
W 410	1-1/2, 2, 3		Foam	Zinc base, aluminum bottom and top cover.

▼ **WR 200**

Stretch Film Cutter

Designed specifically for cutting stretch film with a blade-free mechanism for safer, low-maintenance operation, and a suction-cup base that keeps the unit securely in place. For roll diameters up to 9", 24" working width.



W450 / W453

W 470

W 4730

W 520 / W5201



VIDEO

ITEM NO	Core Size (Inch)	Film Width (Inch)	Handle	Features
W 450	1-1/2 , 2	12-20	PVC	Steel base with nylon bottom and top cover
W 453	1-1/2 , 2 , 3	12-20	PVC	Steel base with aluminum bottom and top cover
W 470	1-1/2 , 2 , 3	12-20	PVC	Steel base with nylon bottom and top cover
W 4730	2 , 3	12-20	PVC	Steel base, aluminum bottom and top cover
W 520	53mm	12-20	Plastic	Plastic base and handle
W 5201	50.4mm	12-20	Plastic	Plastic base and handle

▼ **W 9131**
W 9132



VIDEO

Film Dispenser with extended reach design. The tool is only 1.3 kgs which is the lightest among similar dispensers in the market. Max. tool length is 55" (140cm). With adjustable tension control. Wrap the film from bottom to the top of pallet without back bending or walking backward.

- W 9131: For 2" (50mm) cored film. Film paper core width 400, 430, 450, 475, 500 and 530 mm.
- W 9132: For 3" (75mm) cored film. Film paper core width 12", 15", 18" and 20".



▼ **W 91313**

Max. tool length is 49.6" (126cm). For 2" (50mm) cored film. Film paper core width 400, 430, 450, 475, 500 and 530 mm.



▼ **W 9134**

W9134 is designed without the black bottom cover, allowing the product to stand more steadily. Ideal for users who need to place it securely on a surface. Max. tool length is 132.5 cm. For 50 mm cored film. Film paper core width 12", 15", 18", 20".



▶ **W 914**



VIDEO

Worked for 2" coreless film 400, 430, 450 and 500 mm wide. The tool is 1.47 kgs. Max. tool length is 53" (135cm).



► **W 540** | 3" core film wrapper.



▲ **W 542** | 2" core film adapter.

▼ **W 543** | 2" core film adapter.



◀ **W 560**



Handy Film Wrapper
Core Size: 3 inches
Squeeze the thumb to activate the brake, allowing precise control of film tension. Compact and ergonomic design, perfect for smaller hands, making it ideal for women or users with petite hand sizes.



► **W 565**

Handy Film Wrapper
Core Size: 3 inches (75-76.2mm)
Squeeze the thumb to activate the brake, allowing precise control of film tension. With larger grippers to provide better grip and handling.



◀ **W 5651**



Handy Film Wrapper
Core Size: 3 inches (76.2-78mm)
Squeeze the thumb to activate the brake, allowing precise control of film tension. With larger grippers to provide better grip and handling.



► **W 566**

Handy Film Wrapper
Core Size: 2 inches
Squeeze the thumb to activate the brake, allowing precise control of film tension. With larger grippers to provide better grip and handling.



▼ **W 562**

Handy Film Wrapper
Core Size: 3 inches
Upgraded Version: Squeeze all fingers to activate the brake, ensuring effective control of film tension. Flat ends on both sides allow the film to remain upright on the floor when not in use.



Press the brake with fingers.



• Hold the yellow grip and the black ring turns with stretch film.

▼ **W 564**

Handy Film Wrapper
Core Size: Compatible with 2-inch and 3-inch cores.
Upgraded Version: Squeeze all fingers to activate the brake, ensuring effective control of film tension. Flat ends on both sides allow the film to remain upright on the floor when not in use.



2"core



3"core

W 600 / W 610

3" core film wrapper with plastic mandrel and adjusting nut. For film up to 5" wide.

W 612

1-1/2" core film wrapper with plastic mandrel and adjusting nut. For film up to 5" wide.

W 621 / W 622 / W 6221 / W 623

Plastic film wrapper with spin handle.

- W 621 for 1-1/2" core.
- W 622 for 2" (53mm) core.
- W 6221 for 2" (50.4mm) core.
- W 623 for 3" core.

W 640

1-1/2" core. For film up to 5" wide.

W 650

1-1/2" core film wrapper with tension control and lock function. For film up to 5" wide.

W 700 / W 700 H

3" core plastic film wrapper.

W 731

Plastic film wrapper with spin handle. W 731 for 3" core.



W 600

W 610

W 612



W 621 / W 622 /
W 6221 / W 623

W 640

W 650



W 700 / W 700H

W 731



W 800B

W 800R

W 805G

W 810R

- ▲ **W 800B**
- W 800R**
- W 805G**
- W 810R**

1-1/2" core plastic film wrapper.
W 800B / W 800R: For film up to 5-1/2" wide.
W 805G: For film up to 5" wide.
W 810R: For film up to 4" wide.



- ◀ **W 80000 B-F1**
- W 80000 R-F1**

W 800 B or W 800 R with a roll of film in 100 mm x150 M x22 mic.

- ▶ **W 830**
- W 831**

W 830 for 44.5mm (1-3/4") core.
W 831 for 27mm (1") core.





WL 646 / WL 647



CORELESS FILM

◀ **WL 646**
WL 647

Handle for coreless film in 50-58mm core.
WL 646: up to 6" wide.
WL 647: up to 5" wide.

▶ **WL 107**
WL 109
WL 110

Handle for coreless film in 50-58mm core.
WL 107: 15" wide.
WL 109: 18" wide.
WL 110: 21" wide.



WL 107 / WL 109 / WL 110



◀ **WL 200**
WL 203

Patented screw lock design. Take any width in a range.
WL 200 for film 2" core and width 14" to 20".
WL 203 for film 3" core and width 12" to 19".



VIDEO

▶ **WL 210**
WL 213

Patented screw lock design. Film spins itself while pulling the film.
WL 210 for film 2" core and width from 14" to 19".
WL 213 for film 3" core and width from 12" to 20".



VIDEO



◀ **WA 300B**
WA 300W

Cutter for stretch film, twine, bubble wrap and foam.

*Blade can be replaced when dull.



▶ **WA 320**

Ergonomically designed cutter for stretch film, twine, bubble wrap and foam. Easy to replace blade.

*Blade can be replaced when dull.



◀ **WA 350**

Versatile cutter. Use to cut car safety belt, clothing textile, straps, cord, bubble wrap and film.

*Blade can be replaced when dull.

▶ **WA 340**

This film cutter provides an ergonomic cutting solution for multiple wrapping materials including stretch film, twine, bubble wrap, foam and more. The plastic construction offers strength and impact resistance providing years of durability in harsh working conditions.

*Blade can be replaced when dull.
* Peg hole allows hanging for storage.



◀ **WA 500**

Stud cutter. Cut stud, film, twine, bubble wrap and foam.



◀ **CN 158**

Disposable cutter with stainless steel blade for strap, stretch film, shrink wrap, plastic bag and tape. Blunted tip splits tape easily and safe. This cutter is NSF certified.

▶ **CN 1585**

Same as CN 158 plus with key ring design.



▶ **CN 1583**



VIDEO

NSF certified cutter with stainless steel blade. Wider cutter opening cuts thicker material and quicker. Sharp tip near the opening pierces to bag, box and stretch easily.



◀ **CN 152**

Cut strap, film and box tape.



▶ **CN 154**

Same as CN 152 but ideal for both right and left-handed users.



Left-handed



Right-handed



▶ **CN 1541**

Multi-function cutter with blunted tip retractable safety cutter at other side. Blunted tip is safer and does not damage to contents inside box. Ideal for both right and left-handed.



Left-handed



Right-handed



◀ **CN 170**

Cut strap and box tape. Blunted tip splits tape easily and safely.



▶ **CN 174**

Featuring retractable box slitters. This stretch wrap cutter is suitable for cutting bubble roll, paper, stretch film, and twine.



► **CN 100**

All-in-one package opener. Function as a film, rope, plastic strap cutter, staple remover and tape splitter. A replacement blade is included.

▲ **CN 173**

Multi-function cutter with dual NSF certified blade for longer life time. Unique ergonomic design to provide secure grip. Cut strap, tape, box, air bubble mailer, shrink wrap, stretch film, cable tie, etc.

▼ **CN 271**

Multi-function cutter with pocket clip. Keep your hands free. Wider opening makes cutting thicker material easy. Durable nylon + glass fiber material.

▼ **CN 2713**

Multi-function cutter with rubber handle and pocket clip. Wider opening makes cutting thicker material easy. Cutter head can be replaced if damaged. Custom cutter head available

► **CN 272**

Multi-function cutter with two splitters for double life time.





◀ **CN 176**

Gelatin filter cutter. Also good for cutting polyester material. Easy to use and safer than open blade.

▶ **CN 180**

Lashing strap cutter cuts thick and strong strap in any angles. With a splitter that cuts tapes.



▶ **KP 100**

Letter opener.



▲ **KP 300**



Multi-function cutter with tape splitter which cuts kraft paper, gelatin filter, vinyl sheet, film sheet, soft PVC plastic sheet, lashing strap and bubble wrap.

*4 sided blade for replacement.



▶ **K 163**

Self-retracting knife. Ergonomic design. Aluminum alloy body. Lightweight and good quality.



◀ **K 163 L**

Same as K 163 yet for left-handed user.

▶ **K 200**

Zinc alloy utility knives with double point blade



◀ **K 321 D**

Plastic utility knife.

▶ **K 410**

Snap-Off Blade Knife / Retractable Utility Knife
Retractable safety blade.
Easily snap off the blade tip when dull for continuous use.
Packaging:
Blister Card,
144 cards per carton.



◀ **K 415**

Snap-Off Blade Knife / Retractable Utility Knife
Retractable safety blade.
Easily snap off the blade tip when dull for continuous use.
Packaging:
Blister Card,
192 cards per carton.



► **KB 163**

Blade for K 163 / K 163L.
10 pcs/dispenser.



◄ **KB 520**

Blade for K 200 / K 321D.
20 pcs/tube.



► **KB 560**

Blade for K 200 / K 321D.
10 pcs/tube.



◄ **KB 417**

Snap-off spare blade for K 410 / K 415.
50 pcs/tube.



► **KB 418**

Snap-off spare blade for K 410 / K 415.
10 pcs/tube.



◄ **A 200**

Carton sizer. Working height up to 30cm.
Printed scale on the tool, having inches and centimeters.



► **A 210**

Carton sizer with blade guard.
Working height up to 30cm.
Printed scale on the tool, having both inches and centimeters



► **A 211**

Same as A210, but with only centimeters printed on the tool.



► **A 400**

Staple remover with aluminum handle.
Double lip ensures safe removal of large staples.
Blade replaceable.



◄ **ST 220**
ST 228

ST 220: For 32mm wide x 15mm & 18mm leg staples.
ST 228: For 35mm wide x 15mm & 18mm leg staples.



► **ST 225**
ST 227

ST 225: For 35mm wide x 15mm leg staples.
ST 227: For 35mm wide x 18mm leg staples.



- ▶ **PD 100**
- PD 104**
- PD 107**

Horizontal paper cutter with serrated blade to cut paper and film. Can be mounted on the wall. For roll diameter up to 9".
 PD 100: 24" working width.
 PD 104: 36" working width.
 PD 107: 48" working width.



- ◀ **PD 300**
- PD 304**
- PD 307**

Vertical paper cutter that accommodates one paper roll up to 9" in diameter.
 PD 300: 27" working width.
 PD 304: 36" working width.
 PD 307: 48" working width.



The paper blade is designed that it can be pulled backward and lock in open position. Loading new paper roll only require one person.

- ▶ **PD 308**

Vertical paper cutter with large base for stability. 63" working width. Max. outer diameter 9".



VIDEO



Blade is equipped all the way from top to the bottom of paper roll so the paper can be cut completely.

Paper Cutter - Straight Edge Blade
 Slip-resistant rubber feet for stability during use.

A Thoughtful door latch design secures the clamping arm, keeping the blade safely away while loading paper rolls. Enables one-person roll replacement for safer, easier, and quicker operation.

Accommodates roll diameter up to 24cm



- ▲ **PD 113**
- PD 123**
- PD 133**

Straight Edge Blade

PD113 Working width : 60cm.
 PD123 Working width : 80cm.
 PD133 Working width : 100cm.



Straight Edge Blade



► **PD 4061**
PD 4101



VIDEO

Paper crumpler .
Make void fill easy and fast. Crumple the paper and cut with built-in blade.
Mount to wall or bench.
PD4061: Working width up to 60cm.
PD4101: Working width up to 100cm.



► **PD 460**

Void fill dispenser.
Release the loose fill by squeezing the handles to begin dispensing.
Height adjustable. Max. working height 300cm.



max. 300 cm.



► **PD 462**

1. Equipped with a ratchet mechanism for safe and precise handle height adjustment.
2. Dispensing direction can be adjusted according to the working environment, providing greater flexibility during operation.
3. Height adjustable. Max. working height 300 cm.



Cut packaging foam, foil, bubble wrap, kraft paper, corrugated wrap, PVC plastic roll, film, etc.
2 types of blade are included. Rhombic blade for foam, foil, bubble wrap, thin PVC plastic sheet, and film. Rotary blade for paper and corrugated wrap.



◀ **BD 100-19** | Cassette with Rotary blade.

◀ **BD 100-30** | Cassette with Rhombic blade.



ITEM NO.	Max. Working Width (cm)	Max. Outer Diameter (cm)	Cutter	Length Meter	T-Leg	W x D x H (cm)
BD 100	108	80	•	•	•	137 x 83 x 125
BD 200	155	80	•	•	•	188 x 83 x 125
BD 260	200	80	•	•	•	239 x 83 x 125
BD 122	108	•	•	•	•	137 X 83 X 161
BD 220	155	•	•	•	•	188 X 83 X 161

↔ Casters not included. Must order as additional accessory.



▲ **BD 115 / BD 215**
Single-roll dispenser



BD1150-MT
Length meter with meter assembly set (108cm wide) can be ordered additionally.



BD2150-MT
Length meter with meter assembly set (155cm wide).

BD100-WL
4 casters (with brake) can be ordered additionally to make the stand movable.

▶ **BD117 / BD217**



▲ **BD110 / BD113 / BD210**

ITEM NO.	Max. Working Width (cm)	Max. Outer Diameter (cm)	Cutter	Length Meter	T-Leg	W x D x H (cm)
BD 115	108	•	•	•	•	137 x 83 x 125
BD 215	155	•	•	•	•	188 X 83 X 125
BD 117	108	80	•	•	•	149 x 83 x 125
BD 217	155	80	•	•	•	200 x 83 x 125
BD 110	108	•	•	•	desk top type	125 x 10 x 21
BD 113	120	•	•	•	desk top type	145 x 10 x 21
BD 210	155	•	•	•	desk top type	176 x 10 x 21

↔ Casters not included. Must order as additional accessory.



▲ **BD 105 / BD 205**
Good for perforated roll
Single-roll dispenser



▲ **BD 106 / BD 206 / BD 2081**
Good for perforated roll
Double-roll dispenser



▲ **BD 103 / BD 203** (Blade not included)
Good for perforated roll



▲ **BD 104 / BD 204** (2 types of blade are included.)

▶ **BD 603**

Wall mount bubble wrap dispenser equipped with rhombic blade.



▶ **BD 604**

Good for perforated roll

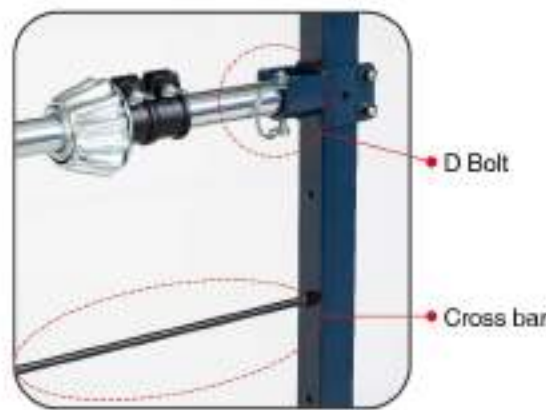

◀ **BD 2082**
Secure bar to prevent falling

▶ **BD 604**

Good for perforated roll



◀ **BD 320 / BD 330**



VIDEO



(Work for packaging roll less than 35 kgs.)

ITEM NO.	Max. Working Width (cm)	Max. Outer Diameter (cm)	Cutter	Length Meter	T-Leg	W x D x H (cm)
BD 105	108				●	134 x 81 x 117
BD 205	155				●	186 x 81 x 117
BD 106	108				●	134 x 81 x 117
BD 206	155				●	186 x 81 x 117
BD 2081	155				●	186 x 81 x 153
BD 2082	155				●	186 x 81 x 153
BD 103	108	80				
BD 203	155	80				
BD 104	108	80	●			
BD 204	155	80	●			

** Casters not included. Must order as additional accessory.

ITEM NO.	Max. Working Width (cm)	Max. Outer Diameter (cm)	Cutter	Length Meter	T-Leg	W x D (cm)
BD 320	108	90	●			
BD 330	155	90	●			
BD 603	155	90	●			185 x 106
BD 604	155	90				185 x 75

▼ BD 631 / BD 633

With Slide Cutter

BD 632 / BD 634

Without Slide Cutter, good for pre-perforated bubble wrap.



• Able to withstand bubble wrap 10 kgs/roll



Bubble wrap stays in place after cutting. Easy to pull for next use.



Measure length.



Storage base.



Latches block the movement of arm and keep it away while loading new bubble wrap roll.

ITEM NO.	Max. Working Width (cm)	Max. Outer Diameter (cm)	Cutter
BD 631	60	45	•
BD 633	91	45	•
BD 632	60	45	
BD 634	91	45	

Keep your hands clean. Our line marking handles are ideal for trench digging, landscaping, plumbing and other general marking.



Aluminum line marker with long handle and arm support. Without wheels so it gives you extra reach when you need it. For paint spray cans which has upright/inverted spray nozzle with max. OD 66mm x 202mm tall. (Custom size available)



Same as LM 100 yet with wheels.





◀ **TA 100**



Floor Marking Tape Applicator

- Apply tape easily as you walk, ensuring efficient and hassle-free floor marking.
 - Heavy design provides steady pressure for secure tape application.
 - Includes extra storage for additional tape rolls.
 - Core size: 3 inches (76mm)
 - Width: 2" - 4" (48 - 110mm)
- Perfect for professional and industrial marking needs.

▼ **TA 203**



Marking Tape Applicator

- Sturdy steel construction with an aluminum extendable handle for durability and ease of use.
 - A larger roller behind the tool applies pressure, ensuring the tape adheres firmly and lies flat on the floor.
 - Core size: 3 inches (76mm)
 - Width: 2" - 4" (48 - 110mm)
- Perfect for efficient and reliable floor marking applications.

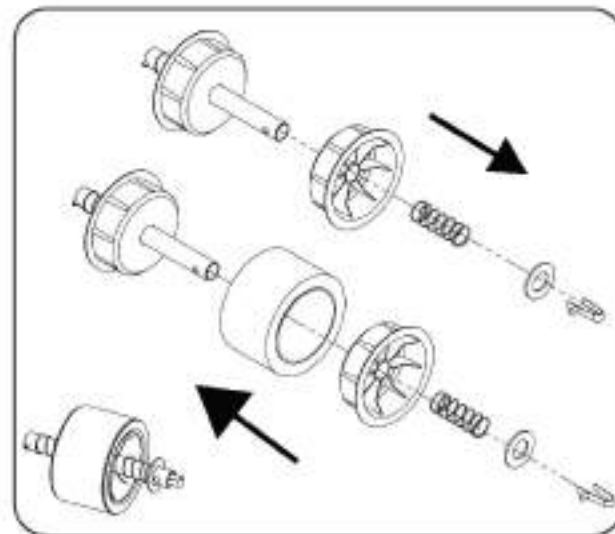

※ **Quick changing tape roll design.**
Remove push button spring, washers and spring from the tape holder assembly. Put safety tape onto core and install all the parts back.



FLAT

ROUND

Flat heating element wires are included with heat sealers.
Round element wires are available only upon request.



◀ **HS 300**
HS 310
HS 316
HS 415

Hand type impulse sealer with plug-in timer, aluminum body and upper lever.

▶ **HS 400**
HS 410
HS 414

Hand type impulse sealer with plug-in timer, aluminum body and upper lever. Equipped with a sliding blade to cut excess matter 1/4" from seal.



HAND TYPE IMPULSE HEAT SEALER

ITEM NO	Voltage (V)	Power (W)	Max. Sealing (mm)	Heating Time (Sec.)
HS 300	110/220/240	260	200 x 2	0 - 1.5
HS 310		380	300 x 2	
HS 316		520	400 x 2	
HS 415		720	500 x 2	
HS 400		260	200 x 2	
HS 410		430	300 x 2	
HS 414		680	400 x 2	



- ◀ **HS 510C**
- HS 515C**
- HS 516C**
- HS 517C**
- HS 519C**

Extra long handle sealer comes with a bigger volume of transformer and a carrying handle for portability.

- ▶ **HS 600**
- HS 610**
- HS 616**
- HS 617**
- HS 619**

Foot type impulse sealer with plug-in timer, aluminum casting body. Imprinter & air control available.



HAND TYPE IMPULSE HEAT SEALER

ITEM NO	Voltage (V)	Power (W)	Max. Sealing (mm)	Heating Time (Sec.)
HS 510C	110/220/240	1400	1000 X 2	0 - 1.5
HS 515C		770	500 X 2	
HS 516C		900	600 X 2	
HS 517C		1000	750 X 2	
HS 519C		1200	900 X 2	

FOOT TYPE IMPULSE HEAT SEALER

ITEM NO	Voltage (V)	Power (W)	Max. Sealing (mm)	Heating Time (Sec.)
HS 600	110/220/240	450	300 X 2.7/5	0 - 1.5
HS 610		600	450 X 2.7/5	
HS 616		800	600 X 2.7/5	
HS 617		1000	750 X 2.7/5	
HS 619		1200	900 X 2.7/5	



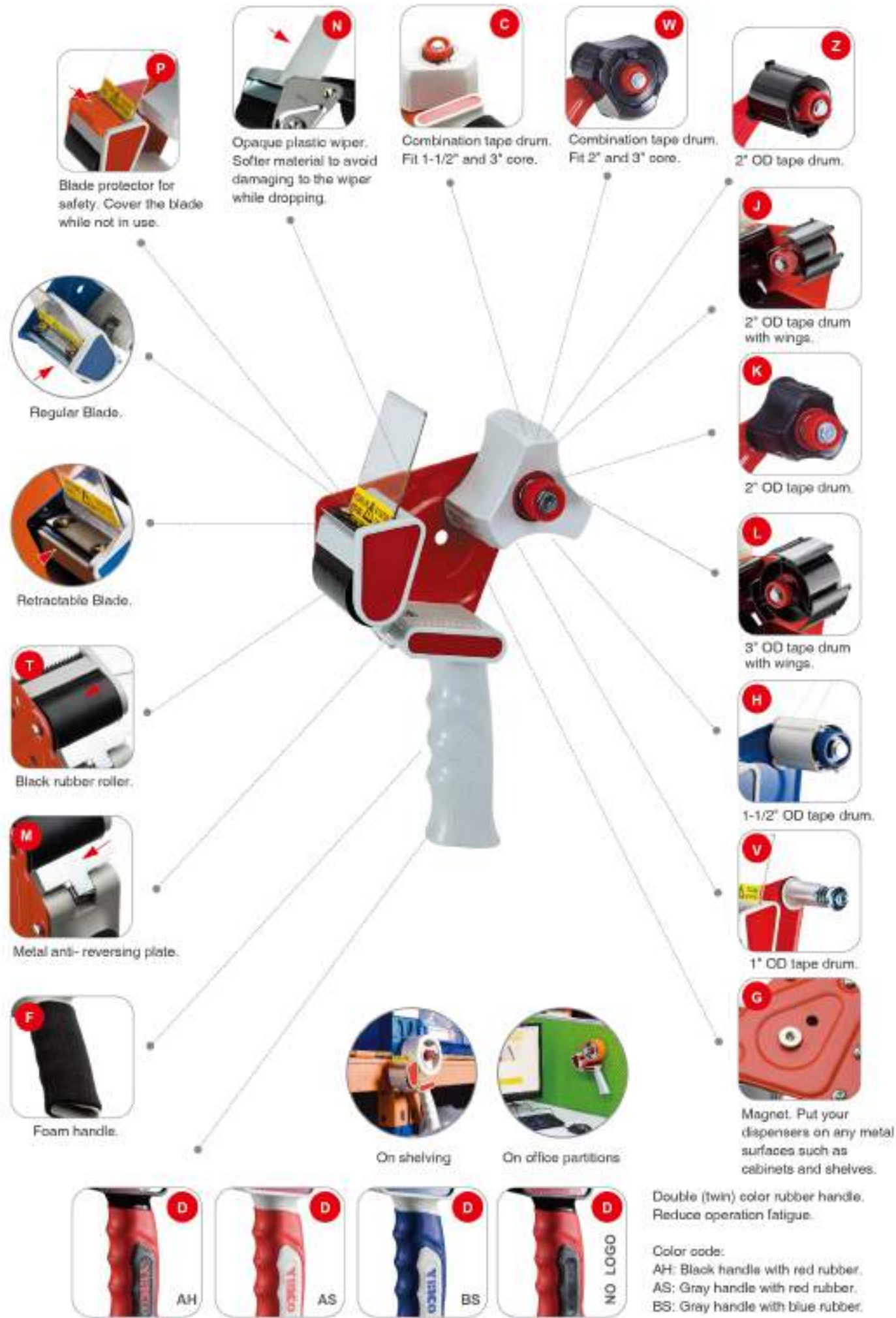

Our Safety Retractable Blade & Easy Replaced Wiper

There are several features to define a good and quality tape dispenser. The ergonomic rubber handle provides operators long time use without fatigue. The rubber roller offers firm and consistent pressure to the tape to apply to the carton. The tape tension adjustment nut allows user to set their preferable tension based on the spec of tape. And one thing very important is the blade. All our blades are made of good quality steel with case harden process. The blade teeth are designed sharp and deep so they cut most of the tapes in the market easy. Some users have requirements for safety blade. With this in mind, we came up a patented safety retractable blade design. Our customer can enjoy a blade that lasts long, easy to replace, and safe.



Blade is hidden inside dispenser.



Only expose when wiper is pushed back.

TAPE IN USE



Blade is away from the tape and box when applying tape.

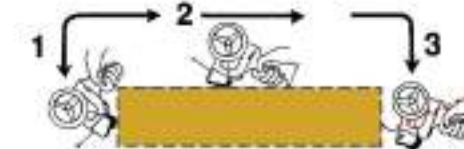

Blade reveal when wiper touch the side of box.

EASY REPLACEMENT OF WIPER



Push the wiper forward to disconnect.



Take the wiper out. Insert a new wiper.



Pull up and click the wiper in place to the dispenser.

Economy Plastic



2" T106

Durable plastic/Retractable Blade

2" T116 / T117

(Retractable Blade)

Sturdy Integrated plastic tape dispenser/ fix brake.

Regular Duty



2" T336-AS / T337-AS

(Retractable Blade)

T336-BS / T337-BS

(Retractable Blade)



T33600-BC3

One piece of T336 dispenser with 2 rolls of tape in blister card pack. Tape: 48mm x 45M x 0.05mm.



2" T110 / T111

(Retractable Blade)

Sturdy Integrated plastic tape dispenser/ adjustable brake.



2" T114PT

Sturdy Integrated plastic tape dispenser/ adjustable brake / blade cover.



3" T533 / T534

(Retractable Blade)



T33600-SP3

One piece of T 336 dispenser with 2 rolls of tape in shrink wrapped pack. Tape: 48mm x45M x0.05mm



3" T531-AS / T532-AS

(Retractable Blade)

T531-BS / T532-BS

(Retractable Blade)

Tape Drum



1" OD tape drum. 2" OD tape drum with wings. 2" OD tape drum. 2" OD tape drum.



1-1/2" OD tape drum. 3" OD tape drum with wings. Combination tape drum. Fit 1-1/2" and 3" core. Combination tape drum. Fit 2" and 3" core.

Safety Blade Cover



Blade protector for safety. Cover the blade while not in use.

Rubber Roller



Black rubber roller.

Handle



Foam handle. Double (twin) color rubber handle. Reduce operation fatigue. Customized color available.

Anti-reversing plate



Metal anti-reversing plate.

Flexible Wiper



Opaque plastic wiper. Softer material to avoid damaging to the wiper while dropping.

Magnet



Magnet. Put your dispensers on any metal surfaces such as cabinets and shelves.



On shelving.



2" T 242 / T 243
(Retractable Blade)
3" T 512 / T 513
(Retractable Blade)



2" T 290-AH / T 291-AH
(Retractable Blade)
3" T 520-AH / T 521-AH
(Retractable Blade)



2" T 290-AS / T 291-AS
(Retractable Blade)
3" T 520-AS / T 521-AS
(Retractable Blade)

Regular Duty



2" T 280 / T 281
(Retractable Blade)
3" T 528



2" T 290-BS / T 291-BS
(Retractable Blade)
3" T 520-BS / T 521-BS
(Retractable Blade)

Medium Duty



2" T 272 / T 273
(Retractable Blade)
3" T 572 / T 573
(Retractable Blade)



2" T 278 / T 279
(Retractable Blade)



2" T 274 / T 275
(Retractable Blade)
3" T 574 / T 575
(Retractable Blade)



Ideal for left-handed users

Tape Drum



1" OD tape drum.



2" OD tape drum with wings.



2" OD tape drum.



2" OD tape drum.



1-1/2" OD tape drum.



3" OD tape drum with wings.



Combination tape drum. Fit 1-1/2" and 3" core.



Combination tape drum. Fit 2" and 3" core.

Safety Blade Cover



Blade protector for safety. Cover the blade while not in use.

Rubber Roller



Black rubber roller.

Handle



Foam handle.



Double (twin) color rubber handle. Reduce operation fatigue. Customized color available.



AS



BS



NO LOGO

Anti-reversing plate



Metal anti-reversing plate.

Flexible Wiper



Opaque plastic wiper. Softer material to avoid damaging to the wiper while dropping.

Magnet



Magnet. Put your dispensers on any metal surfaces such as cabinets and shelves.



On shelving.

Heavy Duty-Level 1



2" T210N

2" tape dispenser with metal frame, adjustable brake, softer plastic wiper and metal anti-reversing plate.



3" T500

3" tape dispenser with adjustable brake and metal anti-reversing plate.



3" T530

3" tape dispenser with adjustable brake and metal anti-reversing plate.



2" T251 / T252
(Retractable Blade)
3" T510 / T511
(Retractable Blade)



4" T553

Heavy Duty-Level 2



▲ 2" T108

One piece solid made metal frame tape dispenser for 2" wide tape with 3" inner core. With anti-reversing plate, tension adjusting nut, and safety blade.



Safety blade



2" T230 / T231
(Retractable Blade)
3" T540 / T541
(Retractable Blade)

Heavy Duty-Level 3



2" T234 / T235
(Retractable Blade)
3" T543 / T544
(Retractable Blade)



2" T234G / T235G
(Retractable Blade)
3" T543G / T544G
(Retractable Blade)

Magnet is available upon request



Tape Drum



1" OD tape drum.



2" OD tape drum with wings.



2" OD tape drum.



2" OD tape drum.



1-1/2" OD tape drum.



3" OD tape drum with wings.



Combination tape drum. Fit 1-1/2" and 3" core.



Combination tape drum. Fit 2" and 3" core.

Safety Blade Cover



Blade protector for safety. Cover the blade while not in use.

Rubber Roller



Black rubber roller.

Handle



Foam handle.



AH



AS



BS



NO LOGO

Double (twin) color rubber handle. Reduce operation fatigue. Customized color available.

Anti-reversing plate



Metal anti-reversing plate.

Flexible Wiper



Opaque plastic wiper. Softer material to avoid damaging to the wiper while dropping.

Magnet



Magnet. Put your dispensers on any metal surfaces such as cabinets and shelves.



On shelving.

Noise Reduce



2" T287 / T288
(Retractable Blade)
3" T523 / T524
(Retractable Blade)



2" T295 / T296
(Retractable Blade)



2" T297 / T298
(Retractable Blade)

Bigger Outer Diameter



2" T260 / T261
(Retractable Blade)
3" T546 / T547
(Retractable Blade)

Trigger Activated Cutter



2" T338

2" T294

Muti Function



2" T248 / T249
(Retractable Blade)

Tape Drum



1" OD tape drum. 2" OD tape drum with wings. 2" OD tape drum. 2" OD tape drum.



1-1/2" OD tape drum. 3" OD tape drum with wings. Combination tape drum. Fit 1-1/2" and 3" core. Combination tape drum. Fit 2" and 3" core.

Safety Blade Cover



Blade protector for safety. Cover the blade while not in use.

Rubber Roller



Black rubber roller.

Handle



Foam handle. Double (twin) color rubber handle. Reduce operation fatigue. Customized color available.

Anti-reversing plate



Metal anti-reversing plate.

Flexible Wiper



Opaque plastic wiper. Softer material to avoid damaging to the wiper while dropping.

Magnet



Magnet. Put your dispensers on any metal surfaces such as cabinets and shelves.



On shelving.

Universal Core



2" T345
Plastic frame.
Spring-loaded bar to hold various core sizes.



3" T536-AH
Metal frame.



2" T340-BS
Metal frame.



3" T538-AH
Metal frame.
With noise reducer.



2" T343-BS
Metal frame.
With noise reducer.

Handle



Foam handle.



Double (twin) color rubber handle. Reduce operation fatigue. Customized color available.



AS



BS



NO LOGO

Flexible Wiper



Opaque plastic wiper.
Softer material to avoid damaging to the wiper while dropping.

Rubber Roller



Black rubber roller.

Universal Core + Easy Load Device



2" T340E-BS
Metal frame.
With easy load device.



VIDEO



2" T343E-BS
Metal frame.
With easy load device and noise reducer.



2" T361-BS
Metal frame.
With easy load device.



3" T561-AH
Metal frame.
With easy load device.



A design that you can push the easy load device up so it won't touch your hand.



2" T366-BS
Metal frame. With easy load device, noise reducer and retractable blade.



3" T563-AH
Metal frame. With easy load device, noise reducer and retractable blade.

Rolls Tape



Mini Tape



◀ **TB300-AY**
TB300-BY

Mini tape dispenser.
Good for branding and advertising.

- 1" width tape, 1" core.
- Product size: 127 x 69 x 29 mm
- Weight: 34g
- Serrated cutter to cut tapes in any material.
- Single hand operation.
- Fit in your pencil pouch and pencil holder.
- Perfect giveaway to promote your company when printed with logo or brand on it.



Adhesive transfer tape



◀ **TD610**

Adhesive transfer tape dispenser for tapes with 1" core and up to 1" wide.



Adhesive transfer tape & glue dot tape



◀ **TD620**

Adhesive transfer tape and dot tape applicator for tapes with 1" core and 13mm & 25mm wide.



VIDEO



TD620-39

Use this adapter kit with TD 620 when you want to use 6mm wide tape.



VHB Tape



◀ **TH500**

Applicator for VHB tapes, PE tapes, PU foam tapes, filament and transfer tapes. Work for tape with 3" core and width up to 50mm.



VIDEO

Dry Wall Joint Tape

▶ **TF110 D**

Use with adhesive fiberglass/mesh tapes. Good on flat seams, inside corner and angles. A combination tape drum good for 3" and 2" core tapes. Adjustable brake and double twin color rubber handle.



◀ **TF111 D**

Same as TF 110 D but with 2" tape drum.



◀ **TF113 D**

Same as TF 110 D but with 2" tape drum.

Filament tape



◀ **T600**
T610

Filament tape dispenser.
T 600 for 3/4" tapes with 3" inner core.
T 610 for 1" tapes with 3" inner core.

▶ **T650**

Metal frame filament tape dispenser for 1" tapes with 3" inner core.



Economy Type



T730R

Compact folding tape dispenser for 2" tapes with 3" inner core.



T720

Plastic tape dispenser with blade cover for added safety. Blade is heat-treated. Handle tapes with 3" inner core and 2" wide.

Regular Type



T754

Sturdy ABS dispenser. Good for 2" width tapes with 3" inner core.



T750

Sturdy ABS dispenser. Good for 2" width tapes with 3" inner core. Retractable safety blade.

Durable Type



T761

For 2" tapes with 3" inner core.

Snail Shape



T814

Snail shape dispenser for 2" wide tapes.

Heavy Duty Metal Frame



◀ **T700** Regular blade / 2" width tape/ 3" core.

▶ **T712** Retractable blade / 2" width tape/ 3" core.



• Retractable safety blade

Folding Edge – Easy to Peel



◀ **T7093** Folding edge tape dispenser with retractable safety blade. For 2" width tape with 3" inner core. Make it easier to remove tape from box cartons.



VIDEO



Tear Drop Shape

▶ **T4001**
T4003
T4005 Tear-drop metal frame dispenser for 3" core tapes. T 4001 for 1" wide tapes. T 4003 for 1-1/2" wide tapes. T 4005 for 2" wide tapes.



◀ **T4003G**
T4005G Tear-drop tape dispenser with magnet for 3" core tapes. Put the dispenser visibly on a metal surface such as cabinet, shelves, forklift, etc. T 4003G for 1-1/2" wide tapes. T 4005G for 2" wide tapes.

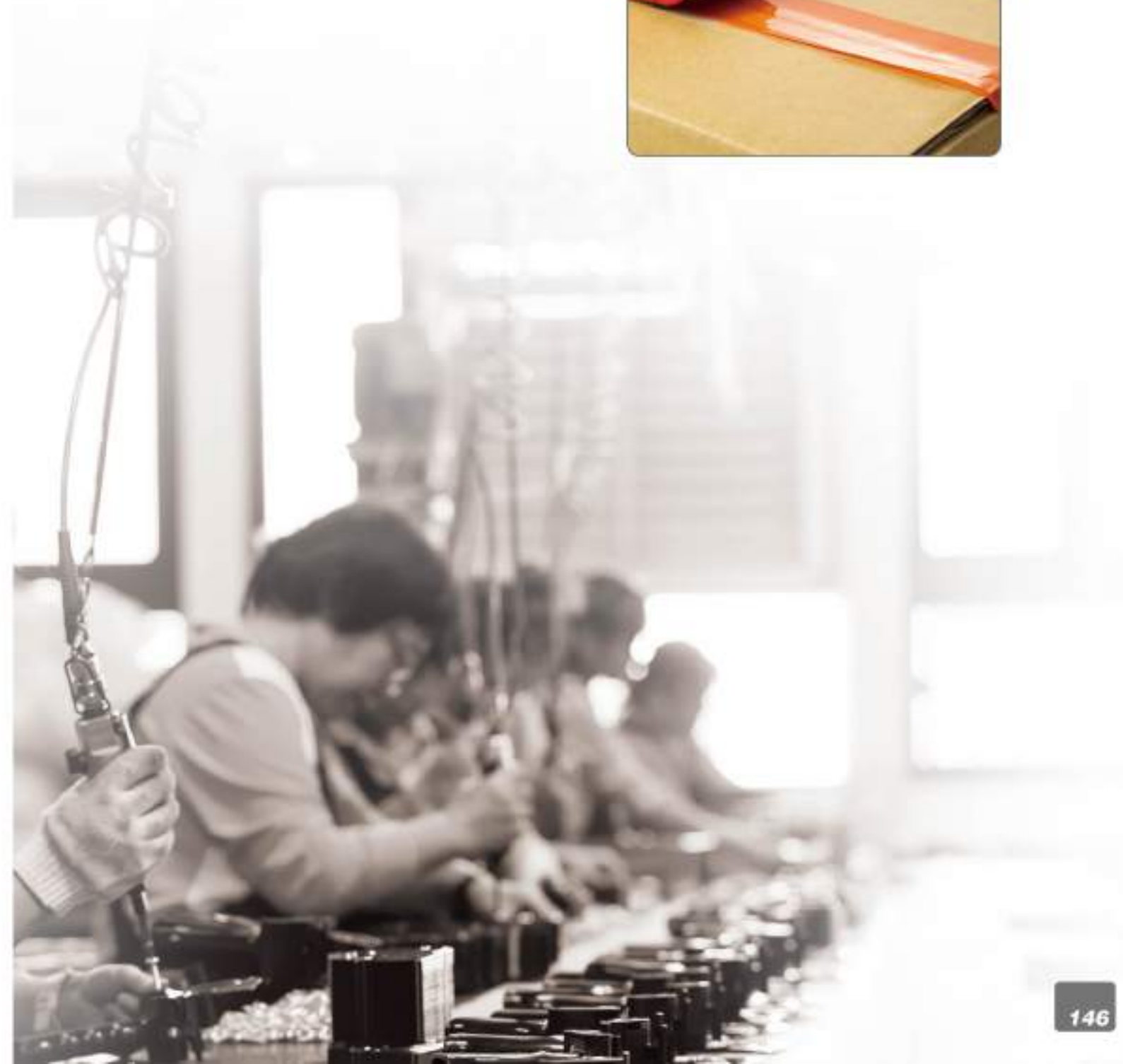

Stationery Type



◀ **T9200**

For 1" tapes with 1" or 3" inner core.

▶ **T9230**

For 1" tapes with 1" or 3" inner core.



Metal shaft

◀ **T9231**

For 1" tapes with 3" inner core.
Metal shaft for longer life time.

Deluxe Divider



T9620
For 1 roll of 2" tape or
2 rolls of 1" tape.



T9621
For 1 roll of 1" tape.



T9622
For 2 rolls of 1" tape.



T9623
For 3 rolls of 1" tape.



T 9628
For 1 roll of 1/2" tape or 1" tape.

**T9620 / T9621
T9622 / T9623 / T9628**

Deluxe multi-roll dispenser with slip resistant base and tier bars to guide tapes. Tier bars create a slope when pulling the tape toward the blade to make cutting tape easy. Embossed metal frame makes this dispenser stronger than a flat sheet metal dispenser. Two screws included form mounting on work bench. Work with 3" inner core tapes.

▶ **T9610**

Good for both 1" and 3" inner core tapes.
For 1 roll of 2" tape or 2 rolls of 1" tape.
C clamp suitable with a reach of up to 55mm.



VIDEO

Extra-weighted



◀ **T96211**

Same as T9621 but with heavy base.

Industrial Type



◀ **T9640** | For tapes with 2" core and 2" wide.

Industrial Extra-weighted Type



For 4 rolls of 1" tape.

T96341 | Same as T9634 but heavy base.

▶ **T9643**
T9644
T9646
Work with 3" inner core tapes. Heavy-duty dispenser with slip resistant base. Two screws included for mounting on bench.



T9643
For 1 roll of 2" tape.



T9644
For 2 rolls of 1" tape or 1 roll of 2" tape..



T9646
For 6 rolls of 1" tape.



For 2 rolls of 1" tape or 1 roll of 2" tape.

T96441 | Dispenser with heavy base. Tool weighs 2.8 kgs.



For 4 rolls of 1" tape.

▲ **T9634** | Heavy-duty dispenser with slip resistance base. Two screws included for mounting on bench. Extra space between the tape rolls so the tapes will not stick together on the blade.



▲ **T9600** | Counter top dispenser with durable steel construction & slip resistant weighted base. Use for any type of tapes with 3" inner core and width up to 3".



For 2 rolls of 1" tape or 1 roll of 2" tape.

T96442 | Dispenser with heavy base. Tool weighs 2.8 kgs.

Hand-carried Type



▲ **T9670P**

Counter top tape dispenser with blade protecting shield, hand carry handle, and slip resistant base. 2" wide x 3" inner core.



Use with paper tape.



Use with packaging tape.

Pouch Tape



◀ **T9714**
T9716

Sturdy plastic construction pouch tape dispenser.
T 9714 4" wide x3" inner core
T 9716 6" wide x3" inner core

▶ **T9704**

Steel frame pouch tape dispenser. 4" wide x 3" inner core.

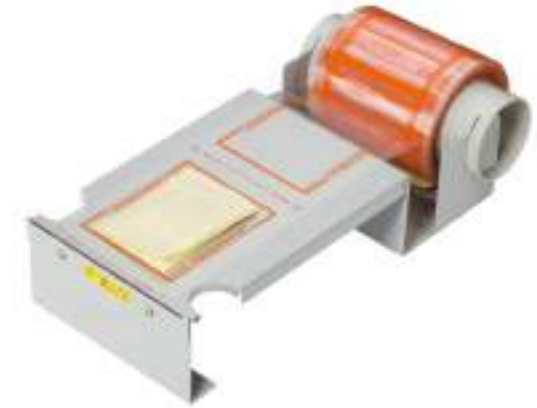

T9301

Water Activated Tape Dispenser with reservoir & moisten brush for gummed paper tapes up to 3" wide. Steel frame with blue painting.



- Special designed brush is hollow, diameter only 0.2mm.
- Hollow brush absorb water with siphon effect, spread water consistently and evenly.
- Brush can be washed and reuse again when the glue stick on it.
- With 2 steel dividers to keep the tape in place and adjust to work with different tape width.

• Hollow Brush



Diameter 0.2mm



• Water Spreading

With brush :
Nice and even



vs.

With fabric covered roller : Uneven



• Stable In Use

With 2 steel dividers to keep tape in place. Suction cups to keep dispenser firmly to bench.

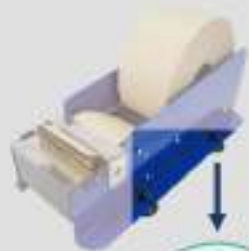

• Low Maintenance & Quick Rinse



Double Sided Tape



◀ TD500



Hand-held liner remover for 3" core tape. For tape width up to 50 mm.



▶ TD300



Table-top liner remover for 3" core tape. For tape width up to 60 mm.



◀ TD310

Portable liner remover for tape with 3" inner core and width up to 60 mm.





T900



T901



▲ **T900
T901**

Metal bag sealer for bag tape with 3" inner core and 5/8" to 3/4" wide.
T 900 without safety trimmer
T 901 with safety trimmer.
Max. Tape OD 160mm.



T 910



T 916

▲ **T910
T916**

Metal bag sealer for bag tape with 1" or 3" inner core and 1/2" wide.
T 910 without trimmer
T 916 with trimmer



▲ **T914**

Metal bag sealer for bag tape with 3" inner core and 3/8" wide.
Max. Tape OD 120mm.



▲ **T918**

Metal bag sealer for bag tape with 3" inner core and 1/2" wide.



T919

Hand-held bag sealer. Perfect to use with any size of trash bags, freezer bags, yard bags, store or kitchen bags. No more twist ties. One tape included in the tool.



T91900-S1

One piece of T919 bag sealer shrink packed with 10 pcs of bag tapes.



T91900-T12

Bag tapes used with T 919 bag sealer. 12 pcs/pack. 12mm X 0.04mm X 10M.



SD200

Wall-Mounted Bag Dispenser
Durable metal construction with epoxy coating. Practical design with two removable knobs, fits all bag bundles up to 400x600 mm. Mounting hole spacing: 170 mm.

► **T9433**
T9435
T9436

Label Dispenser with solid metal frame, non-slip base, and label roll dividers.
Can be mounted on wall or bench.
Two core adapters:
One for label inner core from 2" up and the other for inner core less than 2".
T9433: 6" working width
T9435: 10" working width
T9436: 12" working width



◀ **T9510**
T9520
T9530
T9540
T9550
T9560

Label dispenser with plastic construction.
T 9510 2" working width
T 9520 4" working width
T 9530 6" working width
T 9540 8" working width
T 9550 10" working width
T 9560 12" working width



◀ **T9441**
T9443
T9445
T9446

Label Dispenser with solid metal frame, non-slip base, and label roll dividers.
Can be mounted on wall or bench.
For inner core 3/8" up.
T9441: 2" working width
T9443: 6" working width
T9445: 10" working width
T9446: 12" working width

► **T9511 / T9521 / T9531**
T9541 / T9551 / T9561

Same as T 9510 / T 9520 / T 9530 / T 9540 / T 9550 / T 9560 and a 1-1/2" core adapter included.



◀ **T9512 / T9522 / T9532**
T9542 / T9552 / T9562

Same as T 9510 / T 9520 / T 9530 / T 9540 / T 9550 / T 9560 and a 2-3/4" core adapter included.

► **T94332**

Label dispenser with roll dividers and writing board. 6" working width.



◀ **T94311**

Label Dispenser with solid metal frame, non-slip base, and label roll dividers.
Can be mounted on wall or bench.
2" working width (for one roll of a 2" wide label or for two rolls of 1" wide labels).

► **T9806**
T9809

Label Dispenser with Retractable Blade Protector for Tapes.
Compatible with label/tape core sizes of 48mm and up.
Designed for easy loading and unloading of rolls up to 6" in diameter.
Durable steel frame with a gripper base.
Serrated blade for cutting tapes.
T9806: Suitable for 12" working width.
Holds multiple rolls of labels and specialty tapes totaling 12" in width.
T9809: Suitable for 18" working width.
Holds multiple rolls of labels and specialty tapes totaling 18" in width.



TL300

Work for butt-cut and die-cut labels.
The label is advanced automatically when last one is removed.
With label counter, photo sensor and liner re-winder.
Max. 10" per second speed.
For 1" and 3" cored labels and width from 3/4" to 4".
Fit label OD. max. 9".



VIDEO

**TL310**

Work for butt-cut and die-cut labels especially when they are longer.
It is more ergonomic and efficient to peel downward.
With label counter, photo sensor and liner re-winder.
Max. 10" per second speed.
For 1" and 3" cored labels and width from 3/4" to 4".
Fit label OD. max. 9".



MODEL	TL-300	TL-310
Name	Automatic Label Dispenser	Automatic Label Dispenser
Voltage	Dc 12V	Dc 12V
Power	20W	20W
IP Protection	IP20	IP20
Speed	50-180rpm	50-180rpm
Torque	2kg-cm	2kg-cm
Feed Speed	5-18m/min	5-18m/min
Label Length	20mm-100mm	20mm-230mm
Label Width	6mm-100mm	6mm-100mm
Weight	3.8kg	3.8kg
L/W/H	288 x 270 x 226 mm	320 x 270 x 203 mm
Noise Value	LpA=61.3 dB(A), LwA=72.3 dB(A), K=3 dB(A)	LpA=61.3 dB(A), LwA=72.3 dB(A), K=3 dB(A)